



Request for Bids

*Meghalaya Basin Management Agency on behalf of the
Government of India*

*Funded/Administered by the International Fund for
Agricultural Development (IFAD)*

*for
Procurement of Works*

*Construction of 30 numbers of Collective Marketing
Centers (CMCs) under MLAMP*

*using
National Competitive Bidding*

MBMA/MLAMP/ISC&ED/109/2024/W-20A/132

Issue date: 14th November, 2024



Table of Contents

Section I. Invitation for Bids.....	4
Section II. Instructions to Bidders	7
Section III. Bid Data Sheet (BDS)	26
Section IV. Qualification and Evaluation Criteria	35
Section V. Bidding Forms.....	38
Section V (A). Contractor's Letter of Bid	39
Section V (B). Qualification Information (to be filled by the Bidder)	43
Section V (C). Bid Security Format	45
Section V (D). Bid Securing Declaration Form.....	47
Section V (E). Technical Proposal Documents to be Submitted by the Bidder	48
Section VI. General Conditions of Contract.....	63
Section VII. Specific Conditions of Contract (SCC).....	83
Works Requirements.....	93
Section IX. Drawings.....	95
Section X. Bill of Quantities OR Activity Schedule.....	98
Section XI. Contract Forms	121
Section XI (A). Notice of Intent to Award	122
Section XI (B). Letter of Acceptance	124
Section XI (C). Contract Agreement	125
Section XI (D). Bank Guarantee Form for Advance Payment	127
Section XI (E). Performance Security Form	128
Section XI (F). Self-Certification Form.....	129
Section XI (G). Revised IFAD Policy on Preventing Fraud and Corruption in its Activities and Operations.....	132



Section I. Invitation for Bids

Shillong, India

November, 14 , 2024

Re: Construction of 30 Nos. of Collective Marketing Centers (CMCs) under MLAMP

Ref No. – NCB- 20A

1. The Government of India (Borrower) has received (or in appropriate cases “has applied for”) financing from the International Fund for Agricultural Development (IFAD) and intends to apply a part of the proceeds to the financing of this procurement. The use of any IFAD financing shall be subject to IFAD’s approval, pursuant to the terms and conditions of the financing agreement, as well as IFAD’s rules, policies and procedures. IFAD and its officials, agents and employees shall be held harmless from and against all suits, proceedings, claims, demands, losses and liability of any kind or nature brought by any party in connection with the “Setting up of 30 numbers of Collective Marketing Centers (CMCs) under MLAMP”.
2. The Engagement of contractors for activities related to CMCs Construction includes the construction of 30 nos. of CMCs in Meghalaya to promote and support enterprises, and to create and institutional mechanism to aid the entrepreneurial ecosystem in the state, for an expected duration of completion for about **3 months period**

Bid Reference No.	Description	Lot#	District	Quantity(s)	Bid Security (INR)
NCB – 20A	Construction works	Lot#1	East Jaintia Hills	3	90,000.00
		Lot#2	East Khasi Hills	9	2,70,000.00
		Lot#3	West Khasi Hills	4	1,20,000.00
		Lot#4	South Garo Hills	4	1,20,000.00
		Lot#5	South West Garo Hills	1	30,000.00
		Lot#6	South West Khasi Hills	6	1,80,000.00
		Lot#7	West Garo Hills	2	60,000.00
		Lot#8	West Jaintia Hills	1	30,000.00

3. The employer now invites sealed bids from eligible entities (“bidders”) for the execution and completion of Construction of CMCs which are being bid as a unit price contract based on the bill of quantities.¹

¹ In fixed price contracts, delete “Bill of Quantities” and replace with “Activity Schedule”.

Section II. Instructions to Bidders

Construction of 30 Nos. of Collective Marketing Centers under MLAMP- Ref. No: MBMA/MLAMP/ISC&ED/109/2024/W-20A/



4. This RFB is open to all eligible bidders who wish to participate. Subject to the restrictions stipulated in the bidding document, eligible bidders may not associate with other bidders to carry out the works.
5. A contractor will be selected using the national competitive bidding (NCB) method in accordance with the IFAD Procurement Handbook accessible at www.ifad.org/project-procurement. The NCB process will include a review and verification of qualifications and past performance, including a reference check, prior to the contract award.
6. Please note that a pre-bid conference *will* be held as described in the Bid Data Sheet ("BDS"), Section III of the bidding document.
7. Bids must be delivered to the address:

Executive Director (ED, Technical), MLAMP

Procurement Unit

Meghalaya Basin Management Agency,

O/o Meghalaya Basin Development Authority,

C/o Meghalaya State Housing Financing & Cooperative Society,

Upper Nongrim Hills,

Meghalaya, Shillong - 793003

E-mail: mlamp.procurement@gmail.com

Website: www.mbda.gov.in

and in the manner specified in the BDS ITB 22.1, no later than **December 13th, 2024 by 1600 Hrs IST.**

8. Bidders should be aware that late bids will not be accepted under any circumstance and will be returned unopened at the written request and cost of the bidder. All bids must be accompanied by a bid security (as required) in the manner and amount specified in the Bid Data Sheet.

Please note that electronic bids *shall not* be accepted.

Section II. Instructions to Bidders

Construction of 30 Nos. of Collective Marketing Centers under MLAMP- Ref. No: MBMA/MLAMP/ISC&ED/109/2024/W-20A



Yours sincerely,

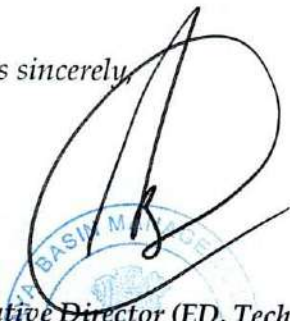

Executive Director (ED, Technical), MLAMP

Procurement Unit

Meghalaya Basin Management Agency,

O/o Meghalaya Basin Development Authority,

C/o Meghalaya State Housing Financing & Cooperative Society,

Upper Nongrim Hills,

Meghalaya, Shillong - 793003

E-mail: mlamp.procurement@gmail.com

Website: www.mbda.gov.in

Section II. Instructions to Bidders

Construction of 30 Nos. of Collective Marketing Centers under MLAMP- Ref. No: MBMA/MLAMP/ISC&ED/109/2024/W-20A/

Section II. Instructions to Bidders

Table of Clauses

1. Scope of bid and funding	9
2. Source of funds	9
3. Prohibited practices	9
4. Sexual Harassment, Sexual exploitation and Abuse.....	12
5. Money laundering and terrorist financing	13
6. SECAP performance standards.....	13
7. Eligible bidders and conflict of interest	13
8. Qualification of the bidder.....	16
9. One bid per bidder.....	16
10. Cost of bidding.....	16
11. Pre-bid meeting and site visit	16
12. Contents of bidding documents	17
13. Clarification and amendments of bidding documents	17
14. Language of bid	17
15. Documents comprising the bid.....	18
16. Bid prices.....	18
17. Currency of bid and payment.....	19
18. Bid validity.....	19
19. Bid security	19
20. Format and signing of bid	20
21. Sealing and marking of bids.....	20
22. Deadline for submission of Bids	21
23. Late bids	21
24. Modification and withdrawal of bids	21
25. Bid opening.....	22
26. Process to be confidential	22
27. Clarification of bids	22
28. Examination of Bids and Determination of Responsiveness.....	22
29. Correction of errors	23

Section II. Instructions to Bidders

Construction of 30 Nos. of Collective Marketing Centers under MLAMP- Ref. No: MBMA/MLAMP/ISC&ED/109/2024/W-20A/



30. Evaluation and comparison of bids	23
31. Award criteria	24
32. Employer's right to accept any bid and to reject any or all bids.....	24
33. Notice of intent to award	24
34. Bid protest.....	24
35. Notification of award and signing of agreement	24
36. Advance payment.....	25
37. Performance security.....	25

Section II. Instructions to Bidders

Construction of 30 Nos. of Collective Marketing Centers under MLAMP- Ref. No: MBMA/MLAMP/ISC&ED/109/2024/W-20A/



Instructions to Bidders

- 1. Scope of bid and funding**

1.1 The employer, as defined in the Bidding Data Sheet (BDS), invites bids for the construction of works, as described in the BDS. The name and identification number of the contract is provided in the BDS.

1.2 The successful bidder shall be expected to complete the works by the required completion date specified in the SCC.
- 2. Source of funds**

2.1 The Recipient has received (or in appropriate cases "has applied for") a financing from the International Fund for Agricultural Development ("the Fund" or "IFAD") in various currencies equivalent to US \$ 50 Million towards the cost of (Megh: Livelihoods and Access to Markets Project), and intends to apply a portion of the proceeds of this loan/grant to eligible payments under this contract.
- 3. Prohibited practices**

3.1 The Fund requires that all beneficiaries of IFAD funding, including the employer and any bidders, implementing partners, service providers, suppliers, sub-suppliers, contractors, sub-contractors, consultants, sub-consultants, and any of their agents (whether declared or not) and personnel observe the highest standards of ethics during the procurement and execution of such contracts, and comply with IFAD's Policy on Preventing Fraud and Corruption in its Activities and Operations, revised on 12 December 2018 and attached as Section XI (G) (EB 2018/125/R.6, hereinafter "IFAD's Anti-Corruption Policy").

3.2 For the purposes of these provisions, and consistent with IFAD's Anticorruption Policy, the terms set forth below are defined as follows, and sometimes referred to collectively as "prohibited practices":

 - (a) "corrupt practice" is the offering, giving, receiving, or soliciting, directly or indirectly, of anything of value in order to improperly influence the actions of another party;
 - (b) "fraudulent practice" is any act or omission, including a misrepresentation, that knowingly or recklessly misleads, or attempts to mislead, a party in order to obtain a financial or other benefit or to avoid an obligation;

Section II. Instructions to Bidders

Construction of 30 Nos. of Collective Marketing Centers under MLAMP- Ref. No: MBMA/MLAMP/ISC&ED/109/2024/W-20A/



- (c) "collusive practice" is an arrangement between two or more parties designed to achieve an improper purpose, including improperly influencing the actions of another party;
- (d) "coercive practice" is impairing or harming, or threatening to impair or harm, directly or indirectly, any party or the property of any party, to improperly influence the actions of that or another party;
- (e) "obstructive practice" is (i) deliberately destroying, falsifying, altering or concealing evidence that may be material to an investigation by the Fund or making false statements to investigators in order to materially impede an investigation by the Fund; (ii) threatening, harassing or intimidating any party in order to prevent that party from disclosing its knowledge of matters relevant to an investigation by the Fund or from pursuing such an investigation; and/or (iii) the commission of any act intended to materially impede the exercise of the Fund's contractual rights of audit, inspection and access to information.

3.3 The Fund will deny approval of a proposed contract award if it determines that the firm or individual recommended for award, or any of its personnel or agents, or its sub-consultants, sub-contractors, service providers, suppliers, sub-suppliers and/or any of their personnel or agents, has, directly or indirectly, engaged in any of the prohibited practices in connection with an IFAD-financed and/or IFAD-managed activity or operation, including in competing for the contract.

3.4 In accordance with IFAD's Anticorruption Policy, the Fund has the right to sanction firms and individuals, including by declaring them ineligible, either indefinitely or for a stated period of time, to participate in any IFAD-financed and/or IFAD-managed activity or operation. This may include ineligibility to: (i) be awarded or otherwise benefit from any IFAD-financed contract, financially or in any other manner; (ii) be a nominated sub-contractor, consultant, manufacturer, supplier, sub-supplier, agent or service provider of an otherwise eligible firm being awarded an IFAD-financed contract; and

Section II. Instructions to Bidders

Construction of 30 Nos. of Collective Marketing Centers under MLAMP- Ref. No: MBMA/MLAMP/ISC&ED/109/2024/W-20A



(iii) receive the proceeds of any loan or grant provided by the Fund.² The Fund also has the right to unilaterally recognize debarments by any of the International Financial Institutions that are members to the Agreement for Mutual Enforcement of Debarment Decisions if such debarments meet the requirements for mutual recognition under the Agreement for Mutual Enforcement of Debarment Decisions.

3.5 In addition, the Fund has the right to, at any time, declare a misprocurement and/or the ineligibility of any expenditures associated with a procurement process or contract if it determines that prohibited practices occurred in connection with this procurement process or contract and that the borrower/recipient has not taken timely and appropriate action, satisfactory to the Fund, to address such practices when they occur.

3.6 Bidders, suppliers, consultants, contractors, and their sub-contractors, sub-consultants, service providers, suppliers, agents and personnel, are required to fully cooperate with any investigation conducted by the Fund into possible prohibited practices, including by making personnel available for interviews and by providing full access to any and all accounts, premises, documents and records (including electronic records) relating to the relevant IFAD-financed and/or IFAD-managed operation or activity and to have such accounts, premises, records and documents audited and/or inspected³ by auditors and/or investigators appointed by the Fund.

3.7 The bidder is obliged to disclose relevant prior sanctions and criminal convictions and any commissions or fees paid or are to be paid to any agents or other party in connection with this procurement process or the execution of the contract.

² For the avoidance of doubt, a sanctioned party's ineligibility to be awarded a contract shall include, without limitation, (i) applying for pre-qualification, expressing interest in a consultancy, and bidding, either directly or as a nominated sub-contractor, nominated consultant, nominated manufacturer or supplier, or nominated service provider, in respect of such contract, and (ii) entering into an addendum or amendment introducing a material modification to any existing contract.

³ Inspections include all fact-finding activities deemed relevant by the Fund to address allegations or other indications of possible Prohibited Practices. Such fact-finding activities may include, but are not limited to: accessing and examining a firm's or individual's financial records and information, and making copies thereof as relevant; accessing and examining any other documents, data or information (whether in hard copy or electronic format) deemed relevant for the investigation or audit, and making copies thereof as relevant; interviewing staff and other relevant individuals; performing physical inspections and site visits; and obtaining third party verifications of information. It is the responsibility of the firm or individual under inspection to ensure effective compliance with their duty to cooperate vis-à-vis any potential local laws or regulations or other potentially conflicting obligations.

Section II. Instructions to Bidders

Construction of 30 Nos. of Collective Marketing Centers under MLAMP- Ref. No: MBMA/MLAMP/ISC&ED/109/2024/W-20A



3.8 The bidder shall keep all records and documents, including electronic records, relating to this procurement process available for a minimum of three (3) years after notification of completion of the process or, in case the bidder is awarded the contract, execution of the contract.

4. Sexual Harassment, Sexual exploitation and Abuse

4.1 The Fund requires that all beneficiaries of IFAD Funding, including the employer and any bidders, implementing partners, service providers, suppliers, sub-suppliers, contractors, sub-contractors, consultants, sub-consultants, and any of their agents (whether declared or not) and personnel comply with IFAD's Policy on Preventing and Responding to Sexual Harassment, Sexual Exploitation and Abuse. For the purpose of this provision, and consistent with IFAD's Policy on Preventing and Responding to Sexual Harassment, Sexual Exploitation and Abuse as it may be amended from time to time, the terms set forth below are defined as follows:

- (a) Sexual harassment means "any unwelcome sexual advance, request for sexual favour or other verbal, non-verbal or physical conduct of a sexual nature that unreasonably interferes with work, alters or is made a condition of employment, or creates an intimidating, hostile or offensive work environment.
- (b) Sexual exploitation and abuse means "any actual or attempted abuse of a position of vulnerability, differential power, or trust, for sexual purposes, including, but not limited to, profiting monetarily, socially or politically from the sexual exploitation of others (sexual exploitation); the actual or threatened physical intrusion of a sexual nature, whether by force or under unequal or coercive conditions (sexual abuse)".

4.2 Employers, suppliers and bidders shall take all appropriate measures to prevent and prohibit sexual harassment and sexual exploitation and abuse on the part of their personnel and subcontractors or anyone else directly or indirectly employed by them or any of subcontractors in the performance of the contract. Contractors, suppliers and bidders shall immediately report to the employer or IFAD any incidents of sexual harassment and sexual exploitation and abuse arising out of or in connection with the performance of the contract or prior to its execution, including convictions, disciplinary measures, sanctions or investigations. The employer may take appropriate measures, including the termination



of the contract, on the basis of proven acts of sexual harassment, sexual exploitation and abuse arising out of or in connection with the performance of the contract.

4.3 The bidder or subcontractor or supplier is required to disclose any relevant prior sanctions, convictions, disciplinary measures or criminal records.

- 5. Money laundering and terrorist financing** 5.1 The Fund requires that all beneficiaries of IFAD funding or funds administered by IFAD, including the employer, any bidders, implementing partners, service providers and suppliers, observe the highest standards of integrity during the procurement and execution of such contracts, and commit to combat money laundering and terrorism financing consistent with IFAD's Anti-Money Laundering and Countering the Financing of Terrorism Policy.
- 6. SECAP performance standards** 6.1 The resulting contract will be implemented in a manner consistent with IFAD's Social, Environmental and Climate Assessment Procedures (SECAP), available on <https://www.ifad.org/en/secap>.
- 7. Eligible bidders and conflict of interest** 7.1 This invitation to bid is open to all national bidders with the required classification as given in the BDS.
- 7.2 Any eligible entity may bid independently or in a joint venture. In the case where a bidder is or proposes to be a JV (a) all members will be jointly and severally liable for the execution of the contract; and (b) the JV will nominate a representative who will have the authority to conduct all business for and on behalf of any and all the members of the JV.
- 7.3 A bidder shall not have any actual, potential or reasonably perceived conflict of interest. A bidder shall declare in the bid submission form any actual, potential or reasonably perceived interest, regardless of its nature, that affects, may affect, or might reasonably be perceived by others to affect, impartiality in any matter relevant to the procurement process, including the selection process and the execution of the contract. A bidder with an actual, potential or reasonably perceived conflict of interest shall be disqualified, unless otherwise explicitly approved by the Fund. The employer requires that the bidder and the supplier hold the project's interests as paramount at all times, strictly avoiding any actual, potential or reasonably perceived conflicts of interest, including actual, potential or reasonably perceived conflicts with other assignments or their own

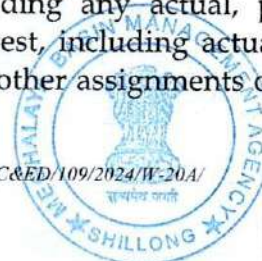

personal and/or corporate interests, and act without any consideration for any other ongoing or future work. Without limitation on the generality of the foregoing, a bidder or supplier, including all parties constituting the bidder or supplier and their respective personnel and affiliates, as well as any subcontractors for any part of the contract, including related services, and their respective personnel and affiliates, may be considered to have an actual, potential or reasonably perceived conflict of interest and disqualified or terminated if they:

- a) have, may have or might reasonably appear to have at least one controlling partner in common with one or more other parties in the process contemplated by this bidding document or the execution of the contract; or
- b) have, may have or might reasonably appear to have the same legal representative as another bidder for purposes of this bid or execution of the contract; or
- c) have, may have or might reasonably appear to have a relationship, directly or through common third parties, that puts them in a position to have access to undue or undisclosed information about or influence over the bid process and the execution of the contract, or influence the decisions of the employer regarding the selection process for this procurement or during the execution of the contract; or
- d) participate, may participate or might reasonably appear to participate in more than one bid in this process; participation by a bidder in more than one bid shall result in the disqualification of all bids in which the party is involved; however, this provision does not limit the inclusion of the same subcontractor in more than one bid; or
- e) are themselves, may be or might reasonably appear to be, or have, may have or might reasonably appear to have a business or family relationship with, a member of the employer's board of directors or its personnel, the Fund or its personnel, or any other individual was, has been or might reasonably be directly or indirectly involved in any part of (i) the preparation of this bidding document, (ii) the selection process for this procurement, or (iii) execution of the contract, unless the actual, potential or reasonably-perceived conflict stemming from this relationship has been

Section II. Instructions to Bidders

Construction of 30 Nos. of Collective Marketing Centers under MLAMP- Ref. No: MBMA/MLAMP/ISC&ED/109/2024/W-20A/

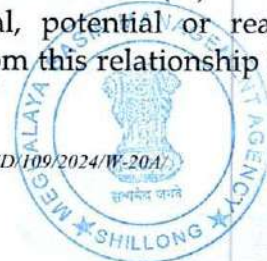

explicitly authorized by the Fund.

7.4 A bidder and the supplier shall have an obligation to disclose any situation of actual, potential or perceived conflict of interest that impacts, may impact, or might reasonably appear to be perceived by others to impact, their capacity to serve the best interest of the employer. Failure to properly disclose any of said situations may lead to appropriate actions, including the disqualification of the bidder, the termination of the Contract and any other as appropriate under the IFAD Policy on Preventing Fraud and Corruption in its Projects and Operations.

7.5 A bidder or supplier, all parties constituting the bidder or supplier, and any subcontractors for any part of the contract, including related services, and their respective personnel and affiliates, will not be any person or entity under a declaration of ineligibility by the Fund for having engaged in prohibited practices as contemplated by ITB clause 3 above. The Fund also has the right to unilaterally recognize debarments by any of the International Financial Institutions that are members to the Agreement for Mutual Enforcement of Debarment Decisions if such debarments meet the requirements for mutual recognition under the Agreement for Mutual Enforcement of Debarment Decisions.

7.6 A bidder or contractor, all parties constituting the bidder or contractor, and any subcontractors for any part of the contract, including related services, and their respective personnel and affiliates not otherwise made ineligible for a reason described in this ITB clause 7 will nonetheless be excluded if:

- a) as a matter of law or official regulation, the government prohibits commercial relations with the country of the bidder or supplier (including any associates, subcontractors and any respective affiliates) provided that the Fund is satisfied that such exclusion does not preclude effective competition for the supply of goods or the contracting of works or services required; or
- b) by an act of compliance with a decision of the United Nations Security Council taken under Chapter VII of the Charter of the United Nations, the government prohibits the issuance of a payment.



- 8. Qualification of the bidder**
- 8.1 All bidders shall provide in accordance with Section IV of the bidding document, qualification information, a preliminary description of the proposed work method and schedule, including drawings and charts, as necessary.
- 8.2 To qualify for award of the contract, bidders shall meet the following minimum
- a) Annual volume of construction work during past two years of at least the amount specified in the BDS;
 - b) experience as prime contractor in the construction of at least one works of a nature and complexity equivalent to the works over the last 3 years (to comply with this requirement, works cited should be at least 80 percent complete);
 - c) proposals for the timely acquisition (own, lease, hire, etc.) of the essential equipment listed in the BDS; and
 - d) key personnel required for the performance of the contract with the qualifications and experience detailed in the BDS and Section IV.
- 9. One bid per bidder**
- 9.1 Each bidder shall submit only one bid, either individually or as a partner in a joint venture. Any bidder who submits or participates in more than one bid will be disqualified. Partners in a joint venture shall be jointly and severally liable for the execution of the contract.
- 10. Cost of bidding**
- 10.1 The bidder shall bear all costs associated with the preparation and submission of his bid, and the employer will in no case be responsible or liable for such costs.
- 11. Pre-bid meeting and site visit**
- 11.1 If so provided for in the BDS, the employer invites the bidder's authorized representative to attend a pre-bid meeting at the place, time and date indicated. The purpose of the pre-bid meeting will be to clarify the issues and to answer questions on any matter that may be raised at that stage.
- 11.2 The bidder, at the bidder's own responsibility and risk, is encouraged to visit and examine the site of works and its surroundings and obtain all information that may be necessary for

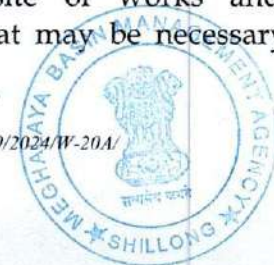

preparing the bid and entering into a contract for construction of the works. The costs of visiting the site shall be at the bidder's own expense.

12. Contents of bidding documents

12.1 The set of bidding documents comprises the documents listed in the table below and addenda in accordance with ITB 13:

- I. Invitation to Bid
- II. Instruction to Bidders
- III. Bid Data Sheet
- IV. Qualification and Evaluation Criteria
- V. Bidding Forms
- VI. General Conditions of Contract
- VII. Special Conditions of Contract
- VIII. Specifications
- IX. Drawings
- X. Bill of Quantities
- XI. Contract Forms

13. Clarification and amendments of bidding documents

13.1 A prospective bidder may request clarification of the bidding documents from the employer in writing. The employer shall respond to such requests if received within 14 calendar days prior to the deadline for the submission of bids. The employer shall also send copies of its response to all bidders who have purchased the bidding documents without identifying the originator of the request. Similarly, prior to the bid submission deadline, the employer may modify the bidding documents by issuing addenda.

14. Language of bid

14.1 All documents relating to the bid and contract shall be in English.

Section II. Instructions to Bidders

Construction of 30 Nos. of Collective Marketing Centers under MLAMP- Ref. No: MBMA/MLAMP/ISC&ED/109/2024/W-20A/



15. Documents comprising the bid

- 15.1 The bid submitted by the bidder shall comprise the following:
- a) The Letter of Bid (in the format indicated in Section V);
 - b) Bid Security or Bid-Securing Declaration;
 - c) Priced Bill of Quantities or priced Activity Schedule;
 - d) list of key personnel and their qualifications as specified in the BDS;
 - e) qualification Information Form and supporting Documents; and;
 - f) The Bidder's Technical Proposal and any other documents required to be completed and submitted by bidders, as specified in the BDS.

16. Bid prices

16.1 The contract shall be for whole works, as described in ITB 1.1, based on the priced bill of quantities or priced activity schedule for lump sum contracts submitted by the bidder. The type of contract (unit price based on bill of quantities or lump sum based on activity schedule) is specified in the BDS.

16.2 The bidder shall fill in rates and prices for all items of the works described in the bill of quantities (for lump sum contracts, an amount against each activity schedule as described in the drawings and specifications). Items for which no rate or price is entered by the bidder will not be paid for by the employer when executed and shall be deemed covered by the other rates and prices in the bill of quantities or activity schedule. The bidder shall also fill in any applicable discounts in its letter of bid.

16.3 All duties, taxes, and other levies payable by the contractor under the contract, or for any other cause, as of the date 14 calendar days prior to the deadline for submission of bids, shall be included in the rates, prices, and total bid price submitted by the bidder (for lump sum contracts, "the rates and prices" are not applicable).

16.4 The rates and prices (or the lump sum price) quoted by the bidder shall be fixed for the duration of the contract and shall not be subject to any adjustment of any kind.



17. Currency of bid and payment

17.1 The currency in which payments shall be made to the contractor under this contract shall be those in which the bid price was expressed. Bid prices shall be expressed in the currency/ies specified in the BDS.

18. Bid validity

18.1 Bids shall remain valid for the period specified in the BDS. The employer may request that the bidders extend the period of validity for a specified additional period. The request and the bidders' responses shall be made in writing. A bidder agreeing to the request will not be required or permitted to otherwise modify the bid, but will be required to extend the validity of bid security or bid-securing declaration for the period of the extension requested by the employer.

19. Bid security

19.1 The bidder shall furnish, as part of its bid, either a bid security or a bid-securing declaration, as specified in the BDS.

19.2 If a bid security is required, it shall be in the amount and currency specified in the BDS, and shall be in one of the following forms:

- a) a bank guarantee or an irrevocable letter of credit issued by a reputable bank located in the employer's country or abroad, in the form provided in the bidding documents or another form acceptable to the employer and valid for thirty (30) days beyond the validity of the bid; or
- b) a cashier's or certified cheque.

19.3 Any bid not secured in accordance with this ITB 19 will be rejected by the employer as non-responsive, pursuant to ITB clause 28.

19.4 Unsuccessful bidders' bid securities will be discharged or returned as promptly as possible but not later than thirty (30) days after the expiration of the period of bid validity prescribed by the employer pursuant to ITB clause 18.

19.5 The successful bidder's bid security (if applicable) will be discharged upon the bidder signing the contract, pursuant to ITB clause 35, and furnishing the performance security, pursuant to ITB clause 37.

19.6 The bid security may be forfeited:

- a) If a Bidder:



- i. Withdraws its bid during the period of bid validity specified by the bidder on the letter of bid, or
 - ii. Does not accept the correction of errors pursuant to ITB clause 29.1(c); or
- b) In the case of a successful bidder, if the bidder fails:
- i. to sign the contract in accordance with ITB clause 35; or
 - ii. to furnish performance security in accordance with ITB clause 37.

20. Format and signing of bid

20.1 The bidder shall prepare one original of the documents comprising the bid as described in ITB Clause 15 clearly marked "original". In addition, the bidder shall submit copies of the bid, in the number specified in the BDS, and clearly marked as "copies". In the event of discrepancy between them, the original shall prevail.

20.2 The original and all copies of the bid shall be typed or written in indelible ink and shall be signed by a person or persons duly authorized to sign on behalf of the bidder. All pages of the bid where entries or amendments have been made shall be by the person or persons signing the bid.

20.3 The bid shall contain no alterations or additions, except those to comply with instructions issued by the employer, or as necessary to correct errors made by the bidder, in which case such corrections shall be initialed by the person or persons signing the bid.

21. Sealing and marking of bids

21.1 The bidder shall seal the original and all copies of the bid in two inner envelopes and one outer envelope, duly marking the inner envelopes as "original" and "copies".

21.2 The inner and outer envelopes shall

- a) be addressed to the employer at the address provided in the BDS;
- b) bear the name and identification number of the contract as defined in the BDS ITB 1.1; and
- c) provide a warning stating that a "bid inside" and that the envelope is not to be opened before the specified time and date for bid opening as defined in the BDS.

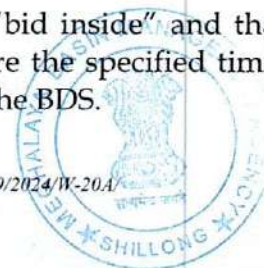

21.3 In addition to the identification required in ITB sub-clause 21.2, the inner envelopes shall indicate the name and address of the Bidder to enable the bid to be returned unopened in case it is declared late, pursuant to ITB sub-clause 23.1.

21.4 If the outer envelope is not sealed and marked as above, the employer will assume no responsibility for the misplacement or premature opening of the bid.

22. Deadline for submission of Bids

22.1 Bids shall be delivered to the employer at the address specified above no later than the time and date specified in the BDS.

22.2 The employer may extend the deadline for submission of bids by issuing an amendment in accordance with ITB sub-clause 13.1, in which case all rights and obligations of the employer and the bidders previously subject to the original deadline will then be subject to the new deadline.

23. Late bids

23.1 Any bid received by the employer after the deadline prescribed in the ITB BDS 22 will be returned unopened to the bidder.

24. Modification and withdrawal of bids

24.1 Bidders may modify or withdraw their bids by giving notice in writing before the deadline prescribed in the ITB BDS 22.

24.2 Each bidder's modification or withdrawal notice shall be prepared, sealed, marked, and delivered in accordance with ITB clause 21, with the outer and inner envelopes additionally marked "modification" or "withdrawal", as appropriate.

24.3 No bid may be modified after the deadline for submission of bids

24.4 Withdrawal of a bid between the deadline for submission of bids and the expiration of the period of bid validity as extended all pursuant to the ITB sub-clause 18.1 may result in the forfeiture of the bid security pursuant to ITB sub-clause 19.6.

24.5 Bidders may offer discounts, or otherwise modify the prices of their bids by submitting bid modifications in accordance with this clause, or included in the original bid submission.



- 25. Bid opening** 25.1 The employer will open the bids, including modifications in the presence of the bidders' representatives who choose to attend at the time and in the place specified in the BDS. The bidders' names, the bid prices, the total amount of each bid, any discounts, any bid modifications and withdrawals, the presence or absence of bid security or bid-securing declaration will be announced by the employer at the opening.
- 26. Process to be confidential** 26.1 Information relating to the examination, clarification, evaluation, and comparison of bids and recommendations for the award of a contract shall not be disclosed until the notice of Intent to award to the successful bidder has been dispatched to all bidders.
- 27. Clarification of bids** 27.1 To assist in the examination, evaluation, and comparison of bids, the employer may, at the employer's discretion, ask any bidder for clarification of the bidder's bid. The request for clarification and the response shall be in writing or by email, or facsimile, but no change in the price or substance of the bid shall be sought, offered, or permitted except as required to confirm the correction of arithmetic errors discovered by the employer in the evaluation of the bids in accordance with ITB clause 29.
- 28. Examination of Bids and Determination of Responsiveness** 28.1 Prior to the detailed evaluation of bids, the employer will determine whether each bid is substantially responsive to the requirements of the bidding documents and that the original of a valid bid security or bid-securing declaration is enclosed within the bid. A substantially responsive bid is one which conforms to all the terms, conditions, and specifications of the bidding documents, without material deviation or reservation. A material deviation or reservation is one (a) which affects in any substantial way the scope, quality, or performance of the works; (b) which limits in any substantial way, inconsistent with the bidding documents, the employer's rights or the bidder's obligations under the contract; or (c) whose rectification would affect unfairly affect the competitive position of other bidders presenting substantially responsive bids.
- 28.2 If a bid is not substantially responsive, it will be rejected by the employer, and may not subsequently be made responsive by correction or withdrawal of the non- conforming deviation or reservation.
- 28.3 If so indicated in the BDS, the employer will assign a technical score to each responsive bid based on the quality of the technical



proposal submitted by the bidder in its bid.

29. Correction of errors

29.1 Bids determined to be substantially responsive will be checked by the employer for any arithmetic errors. Errors will be corrected by the employer as follows:

- a) Where there is a discrepancy between the amounts in figures and in words, the amount in words will govern; and
- b) Where there is a discrepancy between the unit rate and the line item total resulting from multiplying the unit rate by the quantity, the unit rate as quoted will govern;
- c) If a bidder refuses to accept the correction, its bid will be rejected and the corresponding bid security shall be forfeited in accordance with sub-clause 19.6.

30. Evaluation and comparison of bids

30.1 The employer will evaluate and compare only the bids determined to be substantially responsive in accordance with ITB Clause 28.

30.2 In evaluating the bids, the employer will determine the bid which offers the best value for money; namely either the bid with the lowest evaluated bid price or the bid with the highest combined score of quality and price whichever method is indicated in the BDS. In order to arrive at the evaluated bid price the employer shall proceed as follows:

- a) Making any correction for errors pursuant to ITB clause 29;
- b) Excluding provisional sums and the provision, if any, for contingencies in the bill of quantities (or activity schedule for lump sum contracts), but including daywork, where priced competitively;
- c) Making appropriate adjustments to reflect discounts or other price modifications offered in accordance with ITB sub-clause 16.2.

30.3 The employer may waive any minor informality or non-conformity which does not constitute a material deviation, provided



such waiver does not prejudice or affect the relative standing of any bidder. Alternative offers with respect to time for completion or payment terms or any other evaluation factors, if so stipulated in Section IV-Qualification and Evaluation Criteria, will be taken into account in bid evaluation.

- 31. Award criteria** 31.1 Subject to ITB clause 28 and ITB clause 30, the employer will award the contract to the bidder whose bid has been determined to be substantially responsive to the bidding documents and who has offered the best value for money, provided that such bidder is qualified and eligible in accordance with the provisions of ITB clause 7 and ITB clause 8.
- 32. Employer's right to accept any bid and to reject any or all bids** 32.1 Notwithstanding ITB clause 31, the employer reserves the right to accept or reject any bid, and to cancel the bidding process and reject all bids, at any time prior to the award of contract, without thereby incurring any liability to the affected bidder or bidders or any obligation to inform the affected bidder or bidders of the grounds for the employer's action.
- 33. Notice of intent to award** 33.1 Prior to the expiration of the period of bid validity, the employer shall send the notice of intent to award to the successful bidder with a copy to all other bidders. The notice of intent to award shall include a statement that the employer shall issue a formal notification of award and the draft contract agreement after expiration of the period for filing bid protests and the resolution of any bid protests that are submitted. Delivery of the notice of intent to award shall not constitute the formation of a contract between the employer and the successful bidder and no legal or equitable rights will be created through the delivery of the notice of intent to award.
- 34. Bid protest** 34.1 Bidders may protest the results of a procurement only according to the rules established in module M of the IFAD Procurement Handbook.
- 35. Notification of award and signing of agreement** 35.1 The bidder whose bid has been successful will be notified of the award by the employer prior to expiration of the bid validity period by registered letter. This letter (hereinafter and in the condition of contract called the "Letter of Acceptance") will state the sum that the employer will pay the contractor in consideration of the execution, completion, and maintenance of the works by the contractor as prescribed by the contract (hereinafter and in the contract called the "contract price").



35.2 The notification of award will constitute the formation of the contract.

35.3 The employer will send the successful bidder the agreement form provided in the bidding documents incorporating all agreements between the employer and the successful bidder. It will be sent to the successful bidder within 14 calendar days following the notification of award. Within 14 calendar days of receipt, the successful bidder shall sign the agreement and deliver it to the employer.

35.4 Upon receipt of the signed agreement from the bidder, the employer will promptly notify the other bidders that their bids have been unsuccessful.

36. Advance payment 36.1 The employer will provide an advance payment as stipulated in the conditions of contract, subject to a maximum amount, as stated in the BDS. For receiving the advance payment, the bidder shall make an estimate of and include the requirement in its bid, the expenses that will be incurred in order to commence work. These expenses will relate to the purchase of equipment, machinery materials, and for the engagement of staff/labour during the first month beginning with the date of the employer's "notice to proceed" as specified in the SCC.

37. Performance security 37.1 Within twenty-eight (28) days after receipt of the letter of acceptance, the successful bidder shall deliver to the employer a performance security in accordance with the terms of GCC clause 37, and for the amount specified in the BDS, using for that purpose the form of performance security included in Section XI, Contract Forms, or another form acceptable to the employer. A foreign institution providing the performance security shall have a correspondent financial institution located in the employer's country.

37.2 Failure of the successful bidder to submit the above-mentioned performance security or to sign the contract within twenty-eight (28) days of the receipt of the letter of acceptance shall constitute sufficient grounds for the annulment of the award and forfeiture of the bid security. In the event, the employer may award the contract to the next ranking bid that is substantially responsive and which is submitted by a bidder who is determined by the employer to be qualified to perform the contract satisfactorily.



Section III. Bid Data Sheet (BDS)

Instructions to Bid (ITB) Reference	Data relevant to the ITB																
1.1	<p>The employer is: Meghalaya Basin Management Agency</p> <p>The works consist of: <i>Construction of 30 Nos. of Collective Marketing Centers (CMCs) under MLAMP.</i></p> <p>The name and identification number of the contract is: <i>Construction of 30 Nos. of Collective Marketing Centers (CMCs) under MLAMP.; NCB-20A</i></p>																
7.1	<p>Eligible bidders are: Bidder may be an individual, or a firm that is a private entity. Joint Ventures (JV) are not allowed.</p>																
8.	<p>The requisite certificates from the Competent Authority has to be submitted along with the pre - qualification bid.</p> <table border="1" style="width: 100%; border-collapse: collapse;"> <thead> <tr> <th style="width: 10%;">Sl.No</th> <th style="width: 55%;">Discription</th> <th style="width: 35%;">Documents Required</th> </tr> </thead> <tbody> <tr> <td style="text-align: center;">1</td> <td>Registration of the firm/Registration as Civil Bidder/Partnership deed/ Articles of Association.</td> <td>Registration of the firm/Class I or II Registration as Civil Contractors/Partnership deed/ Articles of Association.</td> </tr> <tr> <td style="text-align: center;">2</td> <td>Details of the existing commitments i.e., work on hand and, yet to be completed as on the date of submission of the bid (duly supported with balance work to be done certificates) and works for which bids are submitted.</td> <td>Signed Contract Agreement.</td> </tr> <tr> <td style="text-align: center;">3</td> <td>GST registration certificate & PAN Certificates.</td> <td>GST registration certificate & PAN Certificates.</td> </tr> <tr> <td style="text-align: center;">4</td> <td>Self-declaration to the effect the bidder is not insolvent, in receivership, bankrupt or being wound up or subject to legal</td> <td>To be submitted in the firms letter head</td> </tr> </tbody> </table>		Sl.No	Discription	Documents Required	1	Registration of the firm/Registration as Civil Bidder/Partnership deed/ Articles of Association.	Registration of the firm/Class I or II Registration as Civil Contractors/Partnership deed/ Articles of Association.	2	Details of the existing commitments i.e., work on hand and, yet to be completed as on the date of submission of the bid (duly supported with balance work to be done certificates) and works for which bids are submitted.	Signed Contract Agreement.	3	GST registration certificate & PAN Certificates.	GST registration certificate & PAN Certificates.	4	Self-declaration to the effect the bidder is not insolvent, in receivership, bankrupt or being wound up or subject to legal	To be submitted in the firms letter head
Sl.No	Discription	Documents Required															
1	Registration of the firm/Registration as Civil Bidder/Partnership deed/ Articles of Association.	Registration of the firm/Class I or II Registration as Civil Contractors/Partnership deed/ Articles of Association.															
2	Details of the existing commitments i.e., work on hand and, yet to be completed as on the date of submission of the bid (duly supported with balance work to be done certificates) and works for which bids are submitted.	Signed Contract Agreement.															
3	GST registration certificate & PAN Certificates.	GST registration certificate & PAN Certificates.															
4	Self-declaration to the effect the bidder is not insolvent, in receivership, bankrupt or being wound up or subject to legal	To be submitted in the firms letter head															

Section III. Bid Data Sheet (BDS)

Construction of 30 Nos. of Collective Marketing Centers under MLAMP- Ref. No: MBMA/MLAMP/ISC&ED/109/2024/W-20A



	proceedings for any of these circumstances.	
5	Self-declaration that the bidder's business activities are not suspended or debarred from public procurement by the State Government of Meghalaya or Government of India.	To be submitted in the firms letter head

8.2(a)

Three (3) similar completed works in any Government organization/Government Sector Cooperation/Public Sector Organisation costing not less than the amount equal to:

Lot#	District	Quantity(sites)	Amount (INR)
Lot#1	East Jaintia Hills	3	30,00,000.00
Lot#2	East Khasi Hills	9	90,00,000.00
Lot#3	West Khasi Hills	4	40,00,000.00
Lot#4	South Garo Hills	4	40,00,000.00
Lot#5	South West Garo Hills	1	10,00,000.00
Lot#6	South West Khasi Hills	6	60,00,000.00
Lot#7	West Garo Hills	2	20,00,000.00
Lot#8	West Jaintia Hills	1	10,00,000.00

of the amount as mentioned above.

Note:

1. Experience certificates - For similar nature of work, Completion certificates signed by officer not below the rank of Executive Engineer.
2. Similar work:- The Work of construction of RCC Building at least G+1, RCC framed building with Hybrid structure with composite works of Civil work, Electrical work, Sanitary and water supply etc. shall be considered as similar work.
3. The bidder can quote upto a maximum of 4 Lots. The bidder will be assessed based on the bid capacity even if they are the lowest bidder in the Lot(s), and the award of contract will be done accordingly.

8.2(c)

The essential equipment are to be made available by the successful

Section III. Bid Data Sheet (BDS)

Construction of 30 Nos. of Collective Marketing Centers under MLAMP- Ref. No: MBMA/MLAMP/ISC&ED/109/2024/W-20A



	bidder based on the discussion upon the contract negotiation stage as per the Lots.
8.2(d)	The essential key staff are to be made available by the successful bidder based on the discussion upon the contract negotiation stage.
11.1	<p>The Pre-Bid Meeting will be held at the Office of the Executive Director (Technical), Meghalaya Basin Management Agency (MBMA) Nongrim Hills, Shillong</p> <p>Attendance is strongly advised for all prospective Bidders or their representatives but is not mandatory.</p> <p>Pre-bid conference can also be attended virtually. Interested bidders are requested to send their request to attend the pre-bid conference to mlamp.procurement@gmail.com for sending them the link. The date and time of the pre-bid meeting is <i>11.00 Hrs local time on November 25 , 2024</i></p> <p>The pre-bid response will be on the <i>November 27, 2024.</i></p>
15.1(f)	<p>Bidders shall submit:</p> <p>The RFB will require submission of both Technical and Financial Bids at the same time, but in separate envelopes (two-envelope system). Only the financial envelope of the bidders who comply technically securing the minimum technical score as per the criteria in Annexure-I will be opened whereas the financial bid of the unsuccessful bidders will be returned unopened.</p> <p>In addition to the original bid, the number of copies required is One soft copy of technical bid to be submitted in USB drive.</p> <p>The original signed and company stamped hard copy will prevail in case of any deviations.</p> <p>Technical proposal including method statement, site organization, manning levels and categories, detailed construction program, schedule of material installation etc.</p> <p>Bidders shall submit with their bid: Environmental, Social, Health and Safety (ESHS), Code of conduct, Quality assurance Plan etc.</p> <p>The Technical Bids opening date will be on <i>the 13th of December, 2024</i></p> <p>The date and time for opening of financial Bids will be inform via email only to the bidders who comply technically, whereas the financial bid of the unsuccessful bidders will be returned unopened.</p>
16.1	This shall be a "Unit Price Contract based on Priced Bill of Quantities"
17.1	The currency(ies) of the bid shall be as follows: <i>Indian Rupees (INR)</i>

Section III. Bid Data Sheet (BDS)

Construction of 30 Nos. of Collective Marketing Centers under MLAMP- Ref. No: MBMA/MLAMP/ISC&ED/109/2024/W-20A



	The currency that shall be used for bid evaluation and comparison is: <i>Indian Rupees(INR)</i>																																				
18.1	The period of bid validity shall be <u>120</u> days after the deadline for bid submission specified in the BDS.																																				
19.1 & 19.2	<p>A bid-securing declaration is not required to be submitted with a bid. A bid security is required to be submitted with a bid.</p> <p>The amount of bid security shall be as follows:</p> <table border="1"> <thead> <tr> <th>Lot#</th> <th>District</th> <th>Quantity(sites)</th> <th>Bid Security (INR)</th> </tr> </thead> <tbody> <tr> <td>Lot#1</td> <td>East Jaintia Hills</td> <td>3</td> <td>90,000.00</td> </tr> <tr> <td>Lot#2</td> <td>East Khasi Hills</td> <td>9</td> <td>2,70,000.00</td> </tr> <tr> <td>Lot#3</td> <td>West Khasi Hills</td> <td>4</td> <td>1,20,000.00</td> </tr> <tr> <td>Lot#4</td> <td>South Garo Hills</td> <td>4</td> <td>1,20,000.00</td> </tr> <tr> <td>Lot#5</td> <td>South West Garo Hills</td> <td>1</td> <td>30,000.00</td> </tr> <tr> <td>Lot#6</td> <td>South West Khasi Hills</td> <td>6</td> <td>1,80,000.00</td> </tr> <tr> <td>Lot#7</td> <td>West Garo Hills</td> <td>2</td> <td>60,000.00</td> </tr> <tr> <td>Lot#8</td> <td>West Jaintia Hills</td> <td>1</td> <td>30,000.00</td> </tr> </tbody> </table> <p>Bid security will be in the Form of Irrevocable Bank Guarantees issued by a Nationalized or Scheduled Bank located in India for equivalent or higher values are acceptable as bid security provided it is in favour of the "<i>Meghalaya Basin Management Agency</i>" the certificate shall have a valid of 45 days beyond the validity of the bid.</p>	Lot#	District	Quantity(sites)	Bid Security (INR)	Lot#1	East Jaintia Hills	3	90,000.00	Lot#2	East Khasi Hills	9	2,70,000.00	Lot#3	West Khasi Hills	4	1,20,000.00	Lot#4	South Garo Hills	4	1,20,000.00	Lot#5	South West Garo Hills	1	30,000.00	Lot#6	South West Khasi Hills	6	1,80,000.00	Lot#7	West Garo Hills	2	60,000.00	Lot#8	West Jaintia Hills	1	30,000.00
Lot#	District	Quantity(sites)	Bid Security (INR)																																		
Lot#1	East Jaintia Hills	3	90,000.00																																		
Lot#2	East Khasi Hills	9	2,70,000.00																																		
Lot#3	West Khasi Hills	4	1,20,000.00																																		
Lot#4	South Garo Hills	4	1,20,000.00																																		
Lot#5	South West Garo Hills	1	30,000.00																																		
Lot#6	South West Khasi Hills	6	1,80,000.00																																		
Lot#7	West Garo Hills	2	60,000.00																																		
Lot#8	West Jaintia Hills	1	30,000.00																																		
20.1	The number of copies (in addition to the original) of the bid to be completed and returned shall be one.																																				
21.2(a) & 21.2(c) & 22.1	<p>The employer's address for the purpose of bid submission is</p> <p>Office of the Executive Director (Technical), Procurement Unit, Meghalaya Basin Management Agency, O/o Meghalaya Basin Development Authority, C/o Meghalaya State Housing Financing & Cooperative Society, Upper Nongrim Hills Shillong, India - 793003 Telephone: 0364 2522043 E-mail: mlamp.procurement@gmail.com Website: www.mbda.gov.in</p>																																				

Section III. Bid Data Sheet (BDS)

Construction of 30 Nos. of Collective Marketing Centers under MLAMP- Ref. No: MBMA/MLAMP/ISC&ED/109/2024/W-20A/



22.1 & 25.1	<p>The deadline for submission of bids shall be 1600 Hrs. (local time) on December 13th, 2024 and bids shall be opened immediately thereafter at 1630 Hrs on the same date and at the following address (if different from bid submission address):</p> <p>Office of the Executive Director (Technical), Procurement Unit Meghalaya Basin Management Agency, O/o Meghalaya Basin Development Authority, C/o Meghalaya State Housing Financing & Cooperative Society, Upper Nongrim Hills Shillong, India - 793003 E-mail: mlamp.procurement@gmail.com Website: www.mbda.gov.in</p>
28.2	The weight assigned by the employer for the quality of the Technical Proposal including observance of environmental and social requirements is: Not applicable.
30.2	The best value for money bid evaluation methodology to be used by the employer in evaluating the bids is: Technically qualified bids and Lowest evaluated price
36.1	The mobilization advance shall be limited to 10%(Ten) percent of the contract price (Civil Work) upon submission of the Irrevocable bank Guarantee which is equivalent to the advance amount.
37.1	The form, amount and currency of the performance security shall be a bank guarantee representing 5% (Five) percent of the respective contract price.
38.	Successful bidders if belong to Non Tribal has to obtain the valid Trading Licence from the concerned Autonomous District Council, in the state of Meghalaya on payment of prescribed amount as applicable at the time of application.



ANNEXURE - I

SI No.	CRITERIA	Max Marks								
1	<p>Similar work experience of the Bidder, quantified in terms of number of completed projects during last 5 years in the North Eastern States of Assam, Tripura, Mizoram, Manipur, Nagaland and Arunachal Pradesh. (till last day of month previous to the one in which applications are invited)</p> <p>Completed similar works with value of 80% to 100% of the bidder proposed experience in one contract that has been successfully or substantially completed: 20 marks each capped at a maximum of 1 such projects.</p> <p><u>Similar works:</u> The Work of construction of Building at least G+1, RCC Framed building with Hybrid structure with composite works of Civil work, Electrical work including HVAC, Sanitary and water supply etc. shall be considered as similar work.</p>	20								
2	<p>Prior work experience of the bidders in similar works in Meghalaya during last 5 years (till last day of month previous to the one in which applications are invited)</p> <p>Completed similar nature of works or 80% - 100% of the Bidder experience from any existing work: 15 marks each capped at maximum of 1 such project.</p>	15								
3	<p>Average Annual Turnover of the Bidder from construction works for Last 3 financial years ending on 31st March 2024 Certified by a Chartered Accountant:</p> <table border="1" style="width: 100%; border-collapse: collapse; margin-top: 10px;"> <thead> <tr> <th style="width: 10%;">Lot#</th> <th style="width: 30%;">District</th> <th style="width: 20%;">Quantity(sites)</th> <th style="width: 40%;">Average Annual Turnover (INR)</th> </tr> </thead> <tbody> <tr> <td style="text-align: center;">Lot#1</td> <td style="text-align: center;">East Jaintia Hills</td> <td style="text-align: center;">3</td> <td> <p>More than or Equal to INR 45,00,000 = 20 marks</p> <p>Less than INR 45,00,000 and greater than 20,00,000 =10 mark</p> </td> </tr> </tbody> </table>	Lot#	District	Quantity(sites)	Average Annual Turnover (INR)	Lot#1	East Jaintia Hills	3	<p>More than or Equal to INR 45,00,000 = 20 marks</p> <p>Less than INR 45,00,000 and greater than 20,00,000 =10 mark</p>	20
Lot#	District	Quantity(sites)	Average Annual Turnover (INR)							
Lot#1	East Jaintia Hills	3	<p>More than or Equal to INR 45,00,000 = 20 marks</p> <p>Less than INR 45,00,000 and greater than 20,00,000 =10 mark</p>							

Section III. Bid Data Sheet (BDS)

Construction of 30 Nos. of Collective Marketing Centers under MLAMP- Ref. No: MBMA/MLAMP/ISC&ED/109/2024/W-20A/



Lot#2	East Khasi Hills	9	More than or Equal to INR 1,30,00000 = 20 marks Less than INR 1,30,00000 and greater than 65,00,000 = 10 marks
Lot#3	West khasi hills	4	More than or Equal to INR 60,00,000 = 20 marks Less than INR 60,00,000 and greater than 30,00,000 = 10 marks
Lot#4	South Garo hills	4	More than or Equal to INR 60,00,000 = 20 marks Less than INR 60,00,000 and greater than 30,00,000 = 10 marks
Lot#5	South West Garo Hills	1	More than or Equal to INR 15,00,000 = 20 marks Less than INR 15,00,000 and greater than 7,50,000 = 10 marks
Lot#6	South West Khasi Hills	6	More than or Equal to INR 90,00,000 =20 mark Less than INR 90,00,000 and greater than 45,00,000 = 10 marks

Section III. Bid Data Sheet (BDS)

Construction of 30 Nos. of Collective Marketing Centers under MLAMP- Ref. No: MBMA/MLAMP/ISC&ED/109/2024/W-20A/



Lot#7	West Garo Hills	2	More than or Equal to INR 30,00,000 = 20 marks Less than INR 30,00,000 and greater than 15,00,000 = 10 marks
Lot#8	West jaintia Hills	1	More than or Equal to INR 15,00,000 = 20 marks Less than INR 15,00,000 and greater than 7,50,000 = 10 marks

4 The Bidder has executed minimum quantities of the following items in any ONE project completed in the last 5 Years: 20

Lot#	District	Reinforced Cement Concrete Works	Stone Masonry Works	Electrical Works (Incl. HVAC)
Lot#1	East Jaintia Hills	200 Cum	100 Cum	2,00,000.00
Lot#2	East Khasi Hills	400 cum	200 cum	3,00,000.00
Lot#3	West khasi hills	300 Cum	150 cum	2,50,000.00
Lot#4	South Garo hills	300 Cum	150 cum	2,50,000.00
Lot#5	South West Garo Hills	100 cum	50 cum	2,50,000.00
Lot#6	South West Khasi Hills	300 Cum	150 Cum	2,50,000.000
Lot#7	West Garo Hills	200 Cum	100 Cum	2,50,000.00
Lot#8	West jaintia Hills	100 cum	50 cum	2,50,000.00

Note: Certificates showing quantities of work done signed by technical personnel not below the rank of Executive engineer.

4 **Bid Capacity formula = $(A \times N \times 2) - B$** 25

Where:

A = Maximum value of Civil works executed in any one year during the last 5 (Five) years (updated to current price level) taking into account the



	<p>completed as well as work in progress.</p> <p>N = Number of Years prescribed for completion of work for which Bids / Tenders have been received</p> <p>B = Existing commitments & balance number of ongoing works & works awarded, but yet to start with the Tenderer to be completed in next "N" years</p>	
	TOTAL MARKS	100
<p>In order to meet the eligibility criteria for opening of financial bid, a minimum technical score of 70 marks must be achieved by the bidder</p>		

Section III. Bid Data Sheet (BDS)

Construction of 30 Nos. of Collective Marketing Centers under MLAMP- Ref. No: MBMA/MLAMP/ISC&ED/109/2024/W-20A/



Section IV. Qualification and Evaluation Criteria

1. . Process

This section contains all the criteria that the employer shall use to examine and evaluate bids, qualify bidders and select the winning bid. The bidder shall provide all the information requested in the forms included in Section V, Bidding Forms.

The employer shall evaluate the bids as follows:

A. Bid Examination.

A1. Administrative Examination. This review is conducted to determine that the bid is complete, all required documents are included, all forms are included and are completed and the bid duly signed by the bidder's authorized representative. The bidder may be requested to submit additional information or documentation within a reasonable period of time and/or to correct nonmaterial nonconformities in the bid related to documentation requirements. Determinations made during this review include:

- Determine if the bid is sealed, signed and marked as per the requirements of ITB 20 and ITB 21;
- Determine if the bid security or bid-securing declaration in the correct format is enclosed;
- Determine eligibility of bidder and if it meets required classification;
- Determine if all required forms are included and completed.

A2. Responsiveness Determination. This review will be conducted to determine if the bid is substantially responsive as explained in ITB 28. A substantially responsive bid is one that meets the requirements of the bidding document without material deviation, reservation, or omission. If a bid is not substantially responsive to the requirements of the bidding document, it shall be rejected by the employer and may not be subsequently made responsive by correction of the material deviation, reservation, or omission. However, the employer may request any bidder to clarify its bid according to the procedures set out in ITB 27. Responsiveness determination is based upon a detailed technical review according to the details given below.

Technical Review for Responsiveness Determination:

Documents Comprising the Technical Proposal of Bid. The bidder shall furnish a technical offer including a statement of work methods, equipment, personnel, schedule, and other information as stipulated in Section V Bidding Forms, in sufficient detail to demonstrate the adequacy of the bidder's bid to meet the work requirements and the completion time including environmental and social and safety requirements.



Assessment of adequacy / quality of the technical proposal of the bid. Review of the bidder's technical offer will include an assessment of the bidder's proposed technical method and approach and its consistency with the environmental and social requirement of the employer as documented in the specifications/ works requirements Section VIII. The employer will also evaluate the adequacy of the bidder's program (construction schedule) and its ability to mobilize key equipment and personnel for the contract.

The bidder shall fill the required forms for key personnel and equipment included in Section V-Bidding Forms

B. Financial Evaluation Criteria.

B1. Price-Related Criteria. This evaluation is conducted to determine the evaluated bid price of each technically responsive bid in accordance with the process and criteria detailed below. Only price and price-related criteria shall be considered at this stage of the evaluation. The "evaluated bid price" shall be the bid price adjusted as follows:

- The evaluated bid price excludes provisional sums, but includes daywork items, where priced competitively;
- The evaluated bid price does not include the estimated effect of the price adjustment provisions of the GCC, applied over the period of execution of the contract;
- The evaluated bid price does not include the estimated effect of the price adjustment to rates due to extensions of the bid validity period in accordance with ITB 18;
- The evaluated bid price includes adjustment for correction of arithmetical errors, omissions, clarifications, etc., in accordance with ITB 29; and
- The evaluated bid price includes adjustment due to discounts offered in accordance with ITB 24.5.

In case the technical proposal of the bidder is evaluated on pass/fail (responsive/non-responsive basis) then the bidder with the lowest evaluated cost based on above-mentioned price criteria shall be the one offering the best value for money and is to be recommended for award, subject to post-qualification.

In the case of Multiple Contracts/Lots, bids will be evaluated as follows:

Award criteria for multiple contracts:

Bidders have the option to bid for any one or more lots. bids will be evaluated lot-wise, taking into account discounts offered, if any, for combined lots. The contract(s) will be awarded to the bidder or bidders offering the overall lowest evaluated cost to the employer

Section IV. Qualification and Evaluation Criteria

Construction of 30 Nos. of Collective Marketing Centers under MLAMP- Ref. No: MBMA/MLAMP/ISC&ED/109/2024/W-20A



for combined lots, subject to the selected bidder(s) meeting the required qualification criteria for the lot or combination of lots as the case may be for which they were prequalified.

In case technical merit points are attached to the quality of the bidder's technical proposal then the bid with the best value for money shall be the one that scores the highest combined technical and price merit points (typically minimum of 90 points for bid price and a maximum of 10 points for the quality of the contents of the technical proposal).

C. Bidder's Qualification (Postqualification)

C1 Qualification Review. This process will be conducted to determine if the bidder who submitted the bid with the best value for money satisfies the qualification requirements as listed in ITB 15.1(e). The determination shall be based upon an examination of the documentary evidence of the bidder's qualifications submitted by the bidder as requested in Section V, Bidding Forms, plus the bidder's record of past performance and a review of references and any other source at the employer's discretion. All qualification requirements shall be considered on a pass/fail basis. An affirmative determination of qualification shall be a prerequisite for award of the contract to a bidder.

C2. References and Past Performance Review. The bidder's performance on earlier contracts will be considered in determining if the bidder is qualified for award of the contract. The employer reserves the right to check the performance references provided by the bidder or to use any other source at the employer's discretion.



Section V. Bidding Forms

Table of Contents

Section V (A). Contractor's Letter of Bid	39
Section V (B). Qualification Information (to be filled by the Bidder)	43
Section V (C). Bid Security Format	45
Section V (D). Bid Securing Declaration Form	47
Section V (E). Technical Proposal Documents to be Submitted by the Bidder	48



Section V (A). Contractor's Letter of Bid

The bidder shall fill in and submit this bid form with the bid.

[Bidders letterhead paper]

_____ *[date]*

To : _____ *[name of employer]*

Address _____ *[insert address]*

We, the undersigned, declare that:

1. We have examined and have no reservations to the bidding document, including addenda issued thereto in accordance with the Instructions to Bidders.
2. We offer to execute the **"Construction of 70 Nos. of Collective Markrting Centers (CMCs) under MLAMP"** *[name and identification number of works contract]* in accordance with Section VIII Specifications, Section IX Drawings, Section X Bill of Quantities and the general and specific conditions of contract.
3. The total price of our bid, excluding any discounts offered in item 5 below is: *[insert the total bid price in words and figures, including the various amounts and respective currencies].*
4. The advance payment required is: *[insert advance payment amount required not to exceed the provision in ITB sub-clause 36.1].*
5. The discounts offered and the methodology for their application are:
 - a. Discounts: If our bid is accepted, the following discounts shall apply. *[Specify in detail each discount offered.]*
 - b. Methodology of application of the discounts: The discounts shall be applied using the following: *[Specify in detail the method that shall be used to apply the discount.]*
6. Our bid shall be valid from the date fixed for the bid submission deadline in accordance with ITB sub-clause 22.1, and it shall remain binding upon us and may be accepted at any time before the expiration of that period.



7. If our bid is accepted, we commit to obtain a performance security in accordance with GCC clause 37 and as described in ITB clause 35 for the due performance of the contract.
8. We, including any subcontractors or sub-suppliers for any part of the contract, have nationalities from eligible countries *[Insert the nationality of the bidder, including that of all parties that comprise the bidder, if the bidder is a joint venture, and the nationality of each subcontractor and supplier].*
9. We have no conflict of interest in accordance with ITB clause 7 *[Insert, if needed: ", other than listed below."]* *[If listing one or more conflicts of interest, insert: "We propose the following mitigations for our conflicts of interest: [Insert description of conflict of interest, and proposed mitigations.]"]*
10. Our firm, its associates, including any subcontractors or suppliers for any part of the contract, has not been declared ineligible by the Fund or by the employer, or under the laws or official regulations of the employer's country, in accordance with ITB clause 7 and has not been subject to administrative sanctions, criminal convictions or temporary suspensions beyond those declared in paragraph 11 of this letter of bid.
11. The following criminal convictions, administrative sanctions (including debarments) and/or temporary suspensions have been imposed on our firm and/or any of its directors, partners, proprietors, key personnel, agents, sub-consultants, sub-contractors, consortium and joint venture partners:

Nature of the measure (i.e., criminal conviction, administrative sanction or temporary suspension)	Imposed by	Name of party convicted, sanctioned or suspended (and relationship to consultant)	Grounds for the measure (i.e., fraud in procurement or corruption in contract execution)	Date and time (duration) of measure

If no criminal convictions, administrative sanctions or temporary suspensions have been imposed, indicate "none".

12. We acknowledge notice of the IFAD Revised Policy on Preventing Fraud and Corruption in its Activities and Operations. We have taken steps to ensure that no person acting for us or on our behalf has engaged in any prohibited practices described in ITB clause 3. As part of this, we certify that:

Section V. Bidding Forms

Construction of 30 Nos. of Collective Marketing Centers under MLAMP- Ref. No: MBMA/MLAMP/ISC&ED/109/2024/W-20A/



- a. The prices in this offer have been arrived at independently, without, for the purpose of restricting competition, any consultation, communication, or agreement with any other offeror or competitor relating to:
 - i. Those prices;
 - ii. The intention to submit an offer; or
 - iii. The methods or factors used to calculate the prices offered.
 - b. The prices in this offer have not been and will not be knowingly disclosed by us, directly or indirectly, to any other offeror or competitor before bid opening (in the case of a sealed bid solicitation) or contract award (in the case of a negotiated solicitation) unless otherwise required by law; and
 - c. No attempt has been made or will be made by us to induce any other concern to submit or not to submit an offer for the purpose of restricting competition.
13. We acknowledge notice of the IFAD Policy on Preventing and Responding to Sexual Harassment, Sexual Exploitation and Abuse. We certify that no person acting for us or on our behalf has engaged in any harassment, exploitation or abuse described in ITB clause 4.
14. The following commissions, gratuities, or fees have been paid or are to be paid with respect to the bid process or execution of the contract: *[Insert complete name of each recipient, its full address, the reason for which each commission or gratuity was paid and the amount and currency of each such commission or gratuity.]*

Name of Recipient	Address	Reason	Amount

[if non has been paid or is it to be paid, indicate "none"]

14. We understand that this bid, together with your written acceptance thereof included in your notification of award, shall constitute a binding contract between us, until a formal contract is prepared and executed.

15. We understand that you are not bound to accept the lowest evaluated bid or any other bid that you may receive.

Authorised signatory:

Section V. Bidding Forms

Construction of 30 Nos. of Collective Marketing Centers under MLAMP - Ref. No: MBMA/MLAMP/ISC&ED/109/2024/W-20A/



Names and title of signatory:

Name of bidder:

Address:

Contact details (tel & email):

Section V. Bidding Forms

Construction of 30 Nos. of Collective Marketing Centers under MLAMP- Ref. No: MBMA/MLAMP/ISC&ED/109/2024/W-20A



Section V (B). Qualification Information (to be filled by the Bidder)

Notes on form of Qualification Information

The information to be filled in by bidders in the following pages will be used for purposes of post-qualification as provided for in the Instruction to Bidders. This information will not be incorporated in the contract.

1. Individual bidders or individual members of joint venture

1.1. Constitution or legal status of bidder *[attach copy]*

Place of registration:

Principal place of business:

1.2. Work performed as prime contractor on works of a similar nature and volume of the last two years. Also list details of work under way or committed, including expected completion date.

Project name and country	Name of client and contact person	Type of work performed and year of completion	Percentage of Completion	Value of contract

1.3. Major items of contractor's equipment proposed for carrying out the works. The bidder must list the equipment below and must also fill the relevant forms of the technical proposal.

Item of Equipment	Description, make, and age (years)	Condition (new, good, poor) and number available	Owned, leased (from whom?), or to be purchased (from whom?)
	<i>[etc.]</i>		

1.4. Qualifications and experience of key personnel proposed for administration and execution of the contract. The bidder must list the key staff below and must also fill the relevant forms of the technical proposal-CV forms.

Position	Name	Years of experience (general)	Years of experience in proposed position

1.5. Proposed subcontracts and firms involved: **Not Applicable**

1.6. Information on current litigation in which the bidder is involved. The bidder must list the names of contracts and details as in the table below.

Other party	Cause of dispute	Amount involved

1.7. Proposed program (work method and schedule) descriptions, drawings, and charts, as necessary, to comply with the requirements of the bidding documents must be attached to the bidder's technical proposal.

Section V (C). Bid Security Format

Whereas, *[name of bidder]* (hereinafter called "the bidder") has submitted his bid dated *[date]* for the construction of *[name of contract and procurement number]* (hereinafter called "the bid").

Know all people by these presents that We *[name of bank]* of *[name of country]* having our registered office at *[address]* (hereinafter called "the bank") are bound unto *[name of employer]* (hereinafter called "the employer") in the sum of *[amount]*⁴ for which payment well and truly to be made to the said employer, the bank binds itself, its successors, and assigns by these presents.

Sealed with the common seal of the said bank this *[day]* day of *[month]*, *[year]*. The conditions of this obligation are:

1. If, after bid opening, the bidder withdraws his bid during the period of bid validity specified in the form of bid; or
2. If the bidder having been notified of the acceptance of his bid by the employer during the period of bid validity:
 - a. Fails or refuses to execute the form of agreement in accordance with the Instructions to bidders, if required; or
 - b. Fails or refuses to furnish the performance security, in accordance with the instruction to bidders; or
 - c. Does not accept the correction of the bid price pursuant to clause 24,

We undertake to pay to the employer up to the above amount upon receipt of his first written demand, without the employer's having to substantiate his demand, provided that in his demand the employer will note that the amount claimed by him is due to him owing to the occurrence of one or any of the three conditions, specifying the occurred condition or conditions.

This guarantee will remain in force up to and including *[date]* the date 28 days after the deadline for submission of bids as stated in the Instructions to bidders or as it may be extended by the employer, notice of which extension(s) to the bank is hereby waived. Any demand in respect of this guarantee should reach the bank not later than the above date.

⁴The bidder should insert the amount of the guarantee in words and figures This figure should be the same as shown in clause 14.1 of the Instructions to Bidders.



This guarantee is subject to the Uniform Rules for Demand Guarantees, 2010 Revision, ICC Publication No. 758, except that the supporting statement requirement of Article 15(a) is hereby excluded and as may otherwise be stated above.

Date _____ Signature of the Bank _____

Witness _____ Seal _____

[Signature, name, and address]



Section V (D). Bid Securing Declaration Form

Not Applicable



Section V (E). Technical Proposal Documents to be Submitted by the Bidder

- Key Personnel Schedule (Resume and Declaration Key Personnel) as required by the Employer in Section IV-Qualification and Evaluation Criteria.
- Contractor's Equipment as required by the Employer in Section IV-Qualification and Evaluation Criteria.
- Site Organization
- Method Statement including ES Management Strategies and Implementation Plans
- Mobilization Schedule
- Construction Schedule
- Code of Conduct of Contractor's Personnel



Key Personnel Schedule

Bidders should provide the names and details of the suitably qualified key personnel to perform the contract. The data on their experience should be supplied using the form PER-2 below for each candidate.

Key Personnel

1.	Title of position:	
	Name of candidate:	
	Duration of appointment:	<i>[insert the whole period (start and end dates) for which this position will be engaged]</i>
	Time commitment for this position:	<i>[insert the number of days/week/months/ that has been scheduled for this position]</i>
	Expected time schedule for this position:	<i>[insert the expected time schedule for this position (e.g. attach high level Gantt chart)]</i>
2.	Title of position: <i>[Environmental Specialist]</i>	
	Name of candidate:	
	Duration of appointment:	<i>[insert the whole period (start and end dates) for which this position will be engaged]</i>
	Time commitment for this position:	<i>[insert the number of days/week/months/ that has been scheduled for this position]</i>
	Expected time schedule for this position:	<i>[insert the expected time schedule for this position (e.g. attach high level Gantt chart)]</i>
3.	Title of position: <i>[Health and Safety Specialist]</i>	
	Name of candidate:	
	Duration of appointment:	<i>[insert the whole period (start and end dates) for which this position will be engaged]</i>
	Time commitment for this position:	<i>[insert the number of days/week/months/ that has been scheduled for this position]</i>
	Expected time schedule for this position:	<i>[insert the expected time schedule for this position (e.g. attach high level Gantt chart)]</i>
4.	Title of position: <i>[Social Specialist]</i>	
	Name of candidate:	

Section V. Bidding Forms

Construction of 30 Nos. of Collective Marketing Centers under MLAMP- Ref. No: MBMA/MLAMP/ISC&ED/109/2024/W-20A



	Duration of appointment:	<i>[insert the whole period (start and end dates) for which this position will be engaged]</i>
	Time commitment for this position:	<i>[insert the number of days/week/months/ that has been scheduled for this position]</i>
	Expected time schedule for this position:	<i>[insert the expected time schedule for this position (e.g. attach high level Gantt chart)]</i>
Title of position: Sexual Exploitation, Abuse and Harassment Expert		
5.	<i>[Where a Project SEA risks are assessed to be substantial or high, Key Personnel shall include an expert with relevant experience in addressing sexual exploitation, sexual abuse and sexual harassment cases]</i>	
	Name of candidate:	
	Duration of appointment:	<i>[insert the whole period (start and end dates) for which this position will be engaged]</i>
	Time commitment for this position:	<i>[insert the number of days/week/months/ that has been scheduled for this position]</i>
	Expected time schedule for this position:	<i>[insert the expected time schedule for this position (e.g. attach high level Gantt chart)]</i>
6. Title of position: <i>[insert title]</i>		
	Name of candidate:	
	Duration of appointment:	<i>[insert the whole period (start and end dates) for which this position will be engaged]</i>
	Time commitment for this position:	<i>[insert the number of days/week/months/ that has been scheduled for this position]</i>
	Expected time schedule for this position:	<i>[insert the expected time schedule for this position (e.g. attach high level Gantt chart)]</i>

Section V. Bidding Forms

Construction of 30 Nos. of Collective Marketing Centers under MLAMP- Ref. No: MBMA/MLAMP/ISC&ED/109/2024/W-20A/



Resume and Declaration Key Personnel

Name of bidder

Position [#1]: *[title of position from Form PER-1]*

Personnel information	Name:	Date of birth:
	Address:	E-mail:
	Professional qualifications	
	Academic qualifications	
	Language proficiency: <i>[language and levels of speaking, reading, and writing skills]</i>	
details		
	Address of employer:	
	Telephone	Contact (manager / personnel officer):
	Fax:	
	Job title:	Years with present employers:

Summarize professional experience in reverse chronological order. Indicate particular technical and managerial experience relevant to the project.

Project	Role	Duration of involvement	Relevant experience
<i>[main project details]</i>	<i>[role and responsibilities on the project]</i>	<i>[time in role]</i>	<i>[describe the experience relevant to this position]</i>



Declaration

I, the undersigned key personnel, certify that to the best of my knowledge and belief, the information contained in this form PER-2 correctly describes myself, my qualifications and my experience.

I confirm that I am available as certified in the following table and throughout the expected time schedule for this position as provided in the bid:

Commitment	Details
Commitment to duration of contract:	<i>[insert period (start and end dates) for which this Key Personnel is available to work on this contract]</i>
Time commitment:	<i>[insert the number of days/week/months/ that this Key Personnel will be engaged]</i>

I understand that any misrepresentation or omission in this form may:

- Be taken into consideration during bid evaluation;
- My disqualification from participating in the bid;
- My dismissal from the contract.

Name of key personnel: *[insert name]*

Signature: _____

Date: (day month year): _____

Countersignature of authorized representative of the bidder:

Signature: _____

Date: (day month year): _____



Contractor's Equipment

The bidder shall provide adequate information to demonstrate clearly that it has the capability to meet the requirements for the key equipment listed in Section III Evaluation and Qualification Criteria. A separate form shall be prepared for each item of equipment listed, or for alternative equipment proposed by the bidder. The bidder shall provide all the information requested below, to the extent possible. Fields with asterisk (*) shall be used for evaluation.

Type of Equipment*					
Equipment Information	<table border="1" style="width: 100%; border-collapse: collapse;"> <tr> <td style="width: 40%;">Name of manufacturer,</td> <td>Model and power rating</td> </tr> <tr> <td>Capacity*</td> <td>Year of manufacture*</td> </tr> </table>	Name of manufacturer,	Model and power rating	Capacity*	Year of manufacture*
Name of manufacturer,	Model and power rating				
Capacity*	Year of manufacture*				
Current Status	Current location				
	Details of current commitments				
Source	Indicate source of the equipment <input type="checkbox"/> Owned <input type="checkbox"/> Rented <input type="checkbox"/> Leased <input type="checkbox"/> Specially manufactured				

The following information shall be provided only for equipment not owned by the bidder.

Owner	Name of owner				
	Address of owner				
	<table border="1" style="width: 100%; border-collapse: collapse;"> <tr> <td style="width: 40%;">Telephone</td> <td>Contact name and title</td> </tr> <tr> <td>Fax</td> <td>Telex</td> </tr> </table>	Telephone	Contact name and title	Fax	Telex
Telephone	Contact name and title				
Fax	Telex				
Agreements	Details of rental / lease / manufacture agreements specific to the project <div style="text-align: right;">  </div>				

Method Statement

[insert Method Statement]

In developing its Method Statement, the bidder shall have regard to the environmental and social (ES) provisions of the contract including those as may be more fully described in the specifications (works requirements) in Section X.

The technical proposal must all present the bidder's health and safety plans during execution of the works.



Mobilization Schedule

[insert Mobilization Schedule]



Construction Schedule

[insert Construction Schedule]



Site Organization Locations of Sites

Lot#	NAME OF DISTRICT	NAME OF BLOCK	IVCS	GPS Coordinates	
				Latitude	Longitude
Lot#1	East Jaintia Hills	Khliehriat	Cham Cham IVCS	25.362412	92.232237
		Khliehriat	Samasi IVCS	25.401080	92.546906
		Khliehriat	Byrwai IVCS	25.432862	92.401844
Lot#2	East Khasi Hills	Mawsynram	Mawkasain IVCS	25.265337	91.518527
		Mylliem	Rangbihbih IVCS	25.4983	91.8767
		Mawryngkneng	Mawiong IVCS	25.6793	92.02961
		Mawryngkneng	Puriang IVCS	25.540872	92.09438
		Pynursla	Pynter IVCS	25.26324	91.962562
		Pynursla	Wahkdait IVCS	25.20771	91.987267
		Mawkynew	Jatah Nonglyer IVCS	25.413687	92.056869
		Mawkynew	Laitkyrhong IVCS	25.463793	91.899101
		Mawlai	Iaryntihlang FACT IVCS	25.6869066	91.966895
Lot#3	West Khasi Hills	Mawshynrut	Sangriang IVCS	25.465653	91.241434
		Mawshynrut	Nonglwai IVCS	25.461021	91.328049
		Mairang	Nongrmai IVCS	25.616336	91.618149
		Mawshynrut	Seinduli IVCS	25.660837	91.14363
Lot#4	South Garo Hills	Gasuapara	Megua Songma IVCS Ltd.	25.250533	90.288801
		Chokpot	Balwatgre IVCS Ltd.	25.300907	90.442133
		Baghmar	Nongalbibra IVCS	25.46384584	90.70114246
		Gasuapara	Bamonbajra IVCS Ltd.	25.223516	90.482828
Lot#5	South West Garo Hills	Zikzak	Saliram IVCS Ltd.	89.847507	89.847507
Lot#6	South west khasi hills	Mawkyrwat	Iamonlang IVCS	25.27031	91.226228
		Mawkyrwat	Warsanlyngdoh IVCS	25.403933	91.202565
		Mawkyrwat	Tyllilang IVCS	25.230214	91.3205
		Ranikor	Raibah IVCS	25.25321333	91.43435667
		Mawkyrwat	Rangblang Sohsyniang IVCS	25.413654	91.361515
		Mawkyrwat	Shngimawlein Nongbrei Nongdom IVCS	25.422818	91.483656

Section V. Bidding Forms

Construction of 30 Nos. of Collective Marketing Centers under MLAMP- Ref. No: MBMA/MLAMP/ISC&ED/109/2024/W-20A/



Lot#7	West Garo Hills	Demdema	Beautiful IVCS Ltd.	25.871012	90.062676
		Demdema	Khurang IVCS Ltd.	25.868377	90.068796
Lot#8	West Jaintia Hills	Amlarem	Padu Bah IVCS	25.277426	92.028419

Section V. Bidding Forms

Construction of 30 Nos. of Collective Marketing Centers under MLAMP- Ref. No: MBMA/MLAMP/ISC&ED/109/2024/W-20A/



Code of Conduct for Contractor's Personnel Form

Note to the Employer:

The following minimum requirements shall not be modified. The employer may add additional requirements to address identified issues, informed by relevant environmental and social assessment. The types of issues identified could include risks associated with: labor influx, spread of communicable diseases, and Sexual Exploitation and Abuse (SEA), Sexual Harassment (SH) etc. Delete this box prior to issuance of the bidding documents.

Note to the bidder:

The minimum content of the code of conduct form as set out by the employer shall not be substantially modified. However, the bidder may add requirements as appropriate, including to take into account contract-specific issues/risks. The bidder shall initial and submit the code of conduct form as part of its bid.

Code of Conduct for Contractor's Personnel

We are the contractor, *[enter name of contractor]*. We have signed a contract with *[enter name of employer]* for *[enter description of the works]*. These works will be carried out at *[enter the Site and other locations where the works will be carried out]*. Our contract requires us to implement measures to address environmental and social risks related to the works, including the risks of sexual exploitation, sexual abuse and sexual harassment.

This code of conduct is part of our measures to deal with environmental and social risks related to the works. It applies to all our staff, laborers and other employees at the works site or other places where the works are being carried out. It also applies to the personnel of each subcontractor and any other personnel assisting us in the execution of the works. All such persons are referred to as "contractor's personnel" and are subject to this code of conduct.

This code of conduct identifies the behavior that we require from all contractor's personnel.

Our workplace is an environment where unsafe, offensive, abusive or violent behavior will not be tolerated and where all persons should feel comfortable raising issues or concerns without fear of retaliation.

Required Conduct

Contractor's Personnel shall:

1. Carry out his/her duties competently and diligently;
2. Comply with this code of conduct and all applicable laws, regulations and other requirements, including requirements to protect the health, safety and well-being of other contractor's personnel and any other person;
3. Maintain a safe working environment including by:

Section V. Bidding Forms

Construction of 30 Nos. of Collective Marketing Centers under MLAMP- Ref. No: MBMA/MLAMP/ISC&ED/109/2024/W-20A



- a. Ensuring that workplaces, machinery, equipment and processes under each person's control are safe and without risk to health;
 - b. Wearing required personal protective equipment;
 - c. Using appropriate measures relating to chemical, physical and biological substances and agents; and
 - d. Following applicable emergency operating procedures.
4. Report work situations that he/she believes are not safe or healthy and remove himself/herself from a work situation which he/she reasonably believes presents an imminent and serious danger to his/her life or health;
 5. Treat other people with respect, and not discriminate against specific groups such as women, people with disabilities, migrant workers or children;
 6. Not engage in sexual harassment, which means unwelcome sexual advances, requests for sexual favors, and other verbal or physical conduct of a sexual nature with other contractor's or employer's personnel;
 7. Not engage in sexual exploitation, which means any actual or attempted abuse of position of vulnerability, differential power or trust, for sexual purposes, including, but not limited to, profiting monetarily, socially or politically from the sexual exploitation of another;
 8. Not engage in sexual abuse, which means the actual or threatened physical intrusion of a sexual nature, whether by force or under unequal or coercive conditions;
 9. Not engage in any form of sexual activity with individuals under the age of 18, except in case of pre-existing marriage;
 10. Complete relevant training courses that will be provided related to the environmental and social aspects of the contract, including on health and safety matters, and Sexual Exploitation and Abuse (SEA), and Sexual Harassment (SH);
 11. Report violations of this code of conduct; and
 12. Not retaliate against any person who reports violations of this code of conduct, whether to us or the employer, or who makes use of the grievance mechanism for contractor's personnel or the project's Grievance Redress Mechanism.

Raising Concerns

If any person observes behavior that he/she believes may represent a violation of this code of conduct, or that otherwise concerns him/her, he/she should raise the issue promptly. This can be done in either of the following ways:

1. Contact *[enter name of the contractor's social expert with relevant experience in handling gender-based violence, or if such person is not required under the contract, another individual designated by the contractor to handle these matters]* in writing at this address *[]* or by telephone at *[]* or in person at *[]*; or

Section V. Bidding Forms

Construction of 30 Nos. of Collective Marketing Centers under MLAMP- Ref. No: MBMA/MLAMP/ISC&ED/109/2024/W-203



2. Call [] to reach the contractor's hotline (if any) and leave a message.

The person's identity will be kept confidential, unless reporting of allegations is mandated by the country law. Anonymous complaints or allegations may also be submitted and will be given all due and appropriate consideration. We take seriously all reports of possible misconduct and will investigate and take appropriate action. We will provide warm referrals to service providers that may help support the person who experienced the alleged incident, as appropriate.

There will be no retaliation against any person who raises a concern in good faith about any behavior prohibited by this code of conduct. Such retaliation would be a violation of this code of conduct.

Consequences of violating the code of conduct

Any violation of this code of conduct by contractor's personnel may result in serious consequences, up to and including termination and possible referral to legal authorities.

For contractor's personnel:

I have received a copy of this code of conduct written in a language that I comprehend. I understand that if I have any questions about this code of conduct, I can contact *[enter name of contractor's contact person with relevant experience]* requesting an explanation.

Name of contractor's personnel: *[insert name]*

Signature: _____

Date: (day month year): _____

Countersignature of authorized representative of the contractor:

Signature: _____

Date: (day month year): _____

Attachment 1: Behaviors constituting Sexual Exploitation and Abuse (SEA) and behaviors constituting Sexual Harassment (SH)



Attachment 1 to the Code of Conduct

Behaviors Constituting Sexual Exploitation and Abuse (SEA) and behaviors Constituting Sexual Harassment (SH)

The following non-exhaustive list is intended to illustrate types of prohibited behaviors:

1. Examples of sexual exploitation and abuse include, but are not limited to:
 - A contractor's personnel tells a member of the community that he/she can get them jobs related to the work site (e.g. cooking and cleaning) in exchange for sex.
 - A contractor's personnel that is connecting electricity input to households says that he can connect women headed households to the grid in exchange for sex.
 - A contractor's personnel rapes, or otherwise sexually assaults a member of the community.
 - A contractor's personnel denies a person access to the site unless he/she performs a sexual favor.
 - A contractor's personnel tells a person applying for employment under the contract that he/she will only hire him/her if he/she has sex with him/her.
2. Examples of sexual harassment in a work context
 - Contractor's personnel comment on the appearance of another contractor's personnel (either positive or negative) and sexual desirability.
 - When a contractor's personnel complains about comments made by another contractor's personnel on his/her appearance, the other contractor's personnel comment that he/she is "asking for it" because of how he/she dresses.
 - Unwelcome touching of a contractor's or employer's personnel by another contractor's personnel.
 - A contractor's personnel tells another contractor's personnel that he/she will get him/her a salary raise, or promotion if he/she sends him/her naked photographs of himself/herself.



Section VI. General Conditions of Contract



Section VI. General Conditions of Contract

1. Definitions.....	66
2. Language and Law	68
3. Communication.....	68
4. Prohibited Practices	68
5. Prohibition of Sexual Harassment, Sexual Exploitation and Abuse.....	71
6. SECAP.....	72
7. Sub-contracting and other contractors.....	72
8. Personnel and Labour Requirements.....	72
9. Contractor's and Employer's Risks	73
10. Insurance.....	74
11. Contractor to construct the works.....	75
12. The works to be completed by the completion date.....	75
13. Safety	75
14. Program.....	75
15. Extension of the completion date	75
16. Delays ordered by the project manager.....	75
17. Early warning.....	76
18. Correction of defects.....	76
19. Uncorrected defects.....	76
20. Bill of quantities	76
21. Changes in the quantities	76
22. Payment certificates.....	77
23. Payments.....	77
24. Compensation events.....	77
25. Tax.....	78
26. Liquidated damages.....	78
27. Advance payments.....	78
28. Retention money	79
29. Dayworks.....	79

Section VI. General Conditions of Contract

Construction of 30 Nos. of Collective Marketing Centers under MLAMP- Ref. No: MBMA/MLAMP/ISC&ED/109/2024/W-20A/



30. Cost of repairs	79
31. Completion and taking over	80
32. Final account.....	80
33. Termination action.....	80
34. Payment upon termination	81
35. Property.....	82
36. Release from performance.....	82
37. Resolution of disputes.....	82
38. Performance security.....	82

Section VI. General Conditions of Contract

Construction of 30 Nos. of Collective Marketing Centers under MLAMP- Ref. No: MBMA/MLAMP/ISC&ED/109/2024/W-20A/



General Conditions of Contract

1. Definitions

1.1 Boldface type is used to identify defined terms.

Activity schedule means the priced and completed activity schedule forming part of the bid for a lump sum contract.

Bill of quantities means the priced and completed bill of quantities forming part of the bid for a unit rate contract.

Compensation events are those defined in clause 24 hereunder.

The completion date is the date of completion of the works as certified by the project manager, in accordance with sub-clause 31.

The contract is the contract between the employer and the contractor to execute, complete, and maintain the works. The name and identification number of the contract is given in the SCC.

The contractor is the person or corporate body whose bid to carry out the works has been accepted by the employer.

The contractor's bid is the letter of bid and priced bill of quantities or priced activity schedule submitted by the contractor to the employer.

The contract price is the price stated in the letter of acceptance and thereafter as adjusted in accordance with the provisions of the contract.

Dayworks are additional, varied work inputs subject to payment on a time basis for the contractor's employees and equipment, in addition to payments for associated materials and plant.

Days are calendar days; months are calendar months.

A **defect** is any part of the works not completed in accordance with the contract.

The defects liability period is the period named in the SCC and calculated from the completion date.

Drawings include calculations and other information provided or approved by the employer for the execution of the contract.

The **employer**, as specified in the SCC, is the party who employs the contractor to carry out the works. The name of the employer's representative authorized to deal with the contractor is also given in the SCC.

The **employer's country** is the country in which the employer entity legally resides and operates from, as named in the SCC.

Equipment is the contractor's machinery and vehicles brought temporarily to the site to construct the works.

The **Fund** or **IFAD** means the International Fund for Agricultural Development.

GCC means the general conditions of contract contained in this section.

The **initial contract price** is the contract price listed in the employer's letter of acceptance.

Materials are all supplies, plant (electro-mechanical machinery) and materials including consumables, used by the contractor for incorporation in the works.

The **project manager** is the person named in the SCC (or any other competent person appointed by the employer and notified to the contractor, to act on behalf of the employer) who is responsible for supervising the execution of the works and administering the contract

The **required completion date** is the date on which it is required that the contractor shall complete the works. The required completion date is specified in the SCC. The completion date may be revised only by the employer by issuing an extension of time or an acceleration order.

SCC means the special conditions of contract.

The **site** is the area defined as such in the SCC.

Specification means the specification of the works included in the contract and any modification or addition made or approved

by the employer.

The **start date** is given in the SCC. It is the latest date when the contractor shall commence execution of the works. It does not necessarily coincide with any of the site possession dates.

A **subcontractor** is a person or corporate body who has a contract with the contractor to carry out a part of the work in the contract, which includes work on the site.

Temporary works are works designed, constructed, installed and removed by the contractor that are needed for construction or installation of the works.

A **variation** is an instruction given by the project manager with the approval of the employer which varies the original work requirement or specifications.

The **works** are what the contract requires the contractor to construct, install, and turn over to the employer, as defined in the SCC.

SECAP means IFAD's Environmental, Social and Climate Assessment Procedures.

1.2 This shall be a "unit price contract based on priced bill of quantities" or a "lump sum contract" based on priced activity schedule", as specified in the SCC.

2. Language and Law

2.1 The language of the contract and the law governing the contract are as provided in the SCC.

3. Communication

3.1 Communications between parties that are referred to in these Conditions shall be effective only when in writing. A notice shall be effective only when it is delivered.

4. Prohibited Practices

4.1 The Fund requires that all beneficiaries of IFAD funding, including the employer and any bidders, implementing partners, service providers, suppliers, sub-suppliers, contractors, sub-contractors, consultants, sub-consultants, and any of their agents (whether declared or not) and personnel observe the highest standards of ethics during the procurement and execution of such contracts, and comply with IFAD's Policy on Preventing Fraud and Corruption in its Activities and Operations, revised on 12 December 2018 (EB 2018/125/R.6,



hereinafter "IFAD's Anti-Corruption Policy").

4.2 For the purposes of these provisions, and consistent with IFAD's Anticorruption Policy, the terms set forth below are defined as follows, and sometimes referred to collectively as "prohibited practices":

- (a) "Corrupt practice" is the offering, giving, receiving, or soliciting, directly or indirectly, of anything of value in order to improperly influence the actions of another party;
- (b) "Fraudulent practice" is any act or omission, including a misrepresentation, that knowingly or recklessly misleads, or attempts to mislead, a party in order to obtain a financial or other benefit or to avoid an obligation;
- (c) "Collusive practice" is an arrangement between two or more parties designed to achieve an improper purpose, including improperly influencing the actions of another party;
- (d) "Coercive practice" is impairing or harming, or threatening to impair or harm, directly or indirectly, any party or the property of any party, to improperly influence the actions of that or another party;
- (e) "Obstructive practice" is (i) deliberately destroying, falsifying, altering or concealing evidence that may be material to an investigation by the Fund or making false statements to investigators in order to materially impede an investigation by the Fund; (ii) threatening, harassing or intimidating any party in order to prevent that party from disclosing its knowledge of matters relevant to an investigation by the Fund or from pursuing such an investigation; and/or (iii) the commission of any act intended to materially impede the exercise of the Fund's contractual rights of audit, inspection and access to information.

4.3 The Fund will deny approval of a proposed contract award if it determines that the firm or individual recommended for award, or any of its personnel or agents, or its sub-consultants, sub-contractors, service providers, suppliers, sub-suppliers and/or any of their personnel or agents, has, directly

or indirectly, engaged in any of the prohibited practices in connection with an IFAD-financed and/or IFAD-managed activity or operation, including in competing for the contract.

4.4 In accordance with IFAD's Anticorruption Policy, the Fund has the right to sanction firms and individuals, including by declaring them ineligible, either indefinitely or for a stated period of time, to participate in any IFAD-financed and/or IFAD-managed activity or operation. This may include ineligibility to: (i) be awarded or otherwise benefit from any IFAD-financed contract, financially or in any other manner; (ii) be a nominated sub-contractor, consultant, manufacturer, supplier, sub-supplier, agent or service provider of an otherwise eligible firm being awarded an IFAD-financed contract; and (iii) receive the proceeds of any loan or grant provided by the Fund.⁵ The Fund also has the right to unilaterally recognize debarments by any of the International Financial Institutions that are members to the Agreement for Mutual Enforcement of Debarment Decisions if such debarments meet the requirements for mutual recognition under the Agreement for Mutual Enforcement of Debarment Decisions.

4.5 In addition, the Fund has the right to, at any time, declare a misprocurement and/or the ineligibility of any expenditures associated with a procurement process or contract if it determines that prohibited practices occurred in connection with this procurement process or contract and that the borrower/recipient has not taken timely and appropriate action, satisfactory to the Fund, to address such practices when they occur.

4.6 Bidders, suppliers, consultants, contractors, and their sub-contractors, sub-consultants, service providers, suppliers, agents and personnel, are required to fully cooperate with any investigation conducted by the Fund into possible prohibited practices, including by making personnel available for interviews and by providing full access to any and all accounts, premises, documents and records (including electronic records) relating to the relevant IFAD-financed and/or IFAD-managed

⁵ For the avoidance of doubt, a sanctioned party's ineligibility to be awarded a contract shall include, without limitation, (i) applying for pre-qualification, expressing interest in a consultancy, and bidding, either directly or as a nominated sub-contractor, nominated consultant, nominated manufacturer or supplier, or nominated service provider, in respect of such contract, and (ii) entering into an addendum or amendment introducing a material modification to any existing contract.



operation or activity and to have such accounts, premises, records and documents audited and/or inspected by auditors and/or investigators appointed by the Fund.

4.7 The bidder is obliged to disclose relevant prior sanctions and criminal convictions and any commissions or fees paid or are to be paid to any agents or other party in connection with this procurement process or the execution of the contract.

4.8 The bidder shall keep all records and documents, including electronic records, relating to this procurement process available for a minimum of three (3) years after notification of completion of the process or, in case the bidder is awarded the contract, execution of the contract.

5. Prohibition of Sexual Harassment, Sexual Exploitation and Abuse

5.1 The Fund requires that all beneficiaries of IFAD Funding, including the employer and any bidders, implementing partners, service providers, suppliers, sub-suppliers, contractors, sub-contractors, consultants, sub-consultants, and any of their agents (whether declared or not) and personnel comply with IFAD's Policy on Preventing and Responding to Sexual Harassment, Sexual Exploitation and Abuse. For the purpose of this provision, and consistent with IFAD's Policy on Preventing and Responding to Sexual Harassment, Sexual Exploitation and Abuse as it may be amended from time to time, the terms set forth below are defined as follows:

- (a) Sexual harassment means "any unwelcome sexual advance, request for sexual favour or other verbal, non-verbal or physical conduct of a sexual nature that unreasonably interferes with work, alters or is made a condition of employment, or creates an intimidating, hostile or offensive work environment.
- (b) Sexual exploitation and abuse means "any actual or attempted abuse of a position of vulnerability, differential power, or trust, for sexual purposes, including, but not limited to, profiting monetarily, socially or politically from the sexual exploitation of others (sexual exploitation); the actual or threatened physical intrusion of a sexual nature, whether by force or under unequal or coercive conditions (sexual abuse)".

5.2 Employers, suppliers and bidders shall take all

Section VI. General Conditions of Contract

Construction of 30 Nos. of Collective Marketing Centers under MLAMP- Ref. No: MBMA/MLAMP/ISC&ED/109/2024/W-20A/



appropriate measures to prevent and prohibit sexual harassment and sexual exploitation and abuse on the part of their personnel and subcontractors or anyone else directly or indirectly employed by them or any of subcontractors in the performance of the contract. Contractors, suppliers and bidders shall immediately report to the employer or IFAD any incidents of sexual harassment and sexual exploitation and abuse arising out of or in connection with the performance of the contract or prior to its execution, including convictions, disciplinary measures, sanctions or investigations. The employer may take appropriate measures, including the termination of the contract, on the basis of proven acts of sexual harassment, sexual exploitation and abuse arising out of or in connection with the performance of the contract.

5.3 The bidder or subcontractor or supplier is required to disclose any relevant prior sanctions, convictions, disciplinary measures or criminal records.

6. SECAP

6.1 This contract shall be implemented in a manner consistent with IFAD's Social, Environmental and Climate Assessment Procedures (SECAP), available on <https://www.ifad.org/en/secap>.

7. Sub-contracting and other contractors

7.1 The contractor may subcontract with the approval of the project manager, but may not assign the contract without approval of the employer in writing. Subcontracting shall not alter the contractor's obligations. Not more than the percentage of the works value indicated in the SCC may be sub-contracted to registered contractors. The contractor shall cooperate and share the site with other contractors, public authorities, utilities, and the employer.

8. Personnel and Labour Requirements

8.1 The contractor shall employ the key personnel named in the schedule of key personnel, referred to in the SCC, to carry out the functions stated in the schedule. Replacement of such personnel must be approved by the project manager. The project manager will approve any proposed replacement of key personnel only if their relevant qualifications and abilities are substantially equal to or better than those of the personnel listed in the schedule.

8.2 If the project manager asks the contractor to remove a person who is a member of the contractor's staff or work force,

stating valid reasons including breach of the code of conduct, the contractor shall ensure that the person leaves the site within 72 hours and has no further connection with the work in the contract.

8.3 The contractor shall provide and employ on the site for the execution of the works such skilled, semi-skilled and unskilled labor as is necessary for the proper and timely execution of the contract. The contractor shall provide the contractor's personnel information and documentation that are clear and understandable regarding their terms and conditions of employment. The information and documentation shall set out their rights under relevant labor laws applicable to the contractor's personnel (which will include all ILO core labour standards: prohibition of child labour and worst forms of child labour, forced labour, non-discrimination, freedom of association and collective bargaining), including their rights related to hours of work, wages, overtime, compensation and benefits, as well as those arising from any requirements in the specifications. The contractor's personnel shall be informed when any material changes to their terms or conditions of employment occur.

9. Contractor's and Employer's Risks

9.1 From the starting date until the defects liability certificate has been issued, the risks of personal injury, death, and loss of or damage to property (including, without limitation, the works, materials, and equipment) which are not employer's risks are contractor's risks.

9.2 From the start date until the defects liability certificate has been issued, the following are employer's risks:

- (a) The risk of personal injury, death, or loss of or damage to property (excluding the works, plant, materials, and equipment), which are due to
 - (i) Use or occupation of the site by the works or for the purpose of the works, which is the unavoidable result of the works or
 - (ii) Negligence, breach of statutory duty, or interference with any legal right by the employer or by any person employed by or contracted to him except the contractor.



- (b) The risk of damage to the works, plant, materials, and equipment to the extent that it is due to a fault of the employer or in the employer's design, or due to war or radioactive contamination directly affecting the country where the works are to be executed.

9.3 From the completion date until the defects liability certificate has been issued, the risk of loss of or damage to the works, plant, and materials is an employer's risk except loss or damage due to

- (a) A defect which existed on the completion date,
- (b) An event occurring before the completion date, which was not itself an employer's risk, or
- (c) The activities of the contractor on the site after the completion date.

10. Insurance

10.1 The contractor shall provide, in the joint names of the employer and the contractor, insurance cover from the start date to the end of the defects liability period, in the amounts stated in the SCC, for the following events which are due to the contractor's risks:

- (a) Loss of or damage to the works, equipment and materials;
- (b) Loss of or damage to property (except the works, materials and equipment) in connection with the contract; and
- (c) Personal injury or death and third-party liability.

10.2 Policies and certificates for insurance shall be delivered by the contractor to the project manager for approval within 15 days of receipt by the contractor of the employer's letter of acceptance. All such insurance shall provide for compensation required to rectify the loss or damage incurred. If the contractor fails to provide the required certificates, the contract shall be considered as annulled. However, the employer at its discretion may decide to extend the period for submission of insurance certificates or take out the insurance and deduct the cost of premiums from the contractor's earnings.



- 10.3 Alterations to the terms of an insurance shall not be made without the approval of the employer.
- 11. Contractor to construct the works** 11.1 The contractor shall construct and install the works in accordance with the specifications and drawings.
- 12. The works to be completed by the completion date** 12.1 The contractor shall be given access to the site by the site possession date indicated in the SCC. The contractor shall commence execution of the works by the start date indicated in the SCC and shall carry out the works in accordance with the program submitted by the contractor, as updated with the approval of the project manager, and complete them by the required completion date.
- 13. Safety** 13.1 The contractor shall be responsible for the safety of all activities on the site and shall appoint a health and safety officer if so prescribed in the schedule of the contractor's key personnel.
- 13.2 The contractor shall report immediately to the project manager any health and safety incidents, accidents, injuries that require treatment and all fatalities.
- 14. Program** 14.1 Within the time stated in the SCC, the contractor shall submit to the project manager for its no-objection a program showing the general methods, arrangements, order, and timing for all the activities for construction of the works. The contractor shall update the program at intervals no longer than the period stated in the SCC. The project manager's non-objection to the program shall not alter the contractor's obligations. The contractor may revise the program and submit it to the project manager again at any time. A revised program shall show the effect of variations and compensation events.
- 15. Extension of the completion date** 15.1 The project manager shall extend the completion date if a compensation event occurs or a variation is issued which makes it impossible for completion to be achieved by the required date without the contractor taking steps to accelerate the remaining work, which would cause the contractor to incur additional cost.
- 16. Delays ordered by the project manager** 16.1 The project manager may instruct the contractor to delay the start or progress of any activity within the works. Delays or suspension of work by the project manager which increase the contractor's costs shall be subject to equitable adjustments by the employer.

Section VI. General Conditions of Contract

Construction of 30 Nos. of Collective Marketing Centers under MLAMP- Ref. No: MBMA/MLAMP/ISC&ED/109/2024/W-20A/

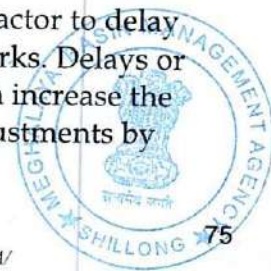

17. Early warning

17.1 The contractor shall inform the project manager at the earliest opportunity of specific likely future events or circumstances that may adversely affect the quality of the work, increase the contract price or delay the execution of the works. The project manager may require the contractor to provide an estimate of the expected effect of the future event or circumstance on the contract price and completion date. The estimate shall be provided by the contractor as soon as reasonably possible.

17.2 The contractor shall cooperate with the project manager in making and considering proposals for how the effect of such an event or circumstance can be avoided or reduced by anyone involved in the works and in carrying out any resulting instruction of the project manager.

18. Correction of defects

18.1 The project manager shall give notice to the contractor of any defects before the end of the defects liability period, which begins at completion, and is defined in the SCC. The defects liability period shall be extended for as long as defects remain to be corrected.

18.2 Every time notice of a defect is given, the contractor shall correct the notified defect within the length of time specified by the project manager in the aforementioned notice.

19. Uncorrected defects

19.1 If the contractor has not corrected a defect within the time specified in the project manager's notice, the project manager will assess the cost of having the defect corrected, and the contractor shall pay this amount, or the employer shall recuperate these amounts by deduction from the amounts due to the contractor.

20. Bill of quantities

20.1 The bill of quantities (in the case of a lump-sum contract this entire clause 20 shall be replaced with a new clause as indicated in the SCC) shall contain items for the construction, installation, testing, and commissioning of the works to be done by the contractor.

20.2 The bill of quantities is used to calculate the contract price. The contractor is paid for the quantity of the work actually done at the rate of the bill of quantities for each item.

21. Changes in the

21.1 If the final quantity of the work done differs from the

Section VI. General Conditions of Contract

Construction of 30 Nos. of Collective Marketing Centers under MLAMP- Ref. No: MBMA/MLAMP/ISC&ED/109/2024/W-20A/



quantities

quantity in the bill of quantities for the particular item by more than 25 percent, provided the change exceeds 1 percent of the initial contract price, the project manager shall adjust the unit rate upwards or downwards for this item commensurate with the impact of the change on the contractor's cost. (For lump-sum contracts, this clause shall be substituted by a new clause as indicated in SCC).

22. Payment certificates

22.1 The contractor shall submit to the project manager monthly statements of the estimated value of the work executed less the cumulative amount certified previously.

22.2 The project manager shall check the contractor's executed work and certify the amount to be paid to the contractor.

22.3 The value of work executed shall be determined by the project manager.

22.4 The value of work executed shall comprise the value of the quantities of the items in the bill of quantities completed. (For lump sum contracts, this clause shall be substituted by a new clause as indicated in the SCC).

22.5 The value of work executed shall include the valuation of variations and compensation events.

23. Payments

23.1 Payments shall be adjusted for deductions of the advance payments and retention. The employer shall pay the contractor the amounts certified by the project manager within 45 days of the date of each certificate submitted by the contractor. If the employer makes a late payment, the contractor shall be paid interest on the late payment in the next payment. Interest shall be calculated from the date by which the payment should have been made, up to the date when the late payment is made, at the rate of interest prevailing at the local banks for construction loans.

23.2 Items of the works for which no rate or price has been entered in the bill of quantities shall not be paid for by the employer and shall be deemed covered by other rates and prices in the contract.

24. Compensation events

24.1 The following shall be compensation events:

- (a) The employer does not give access to a part of the site by



the site possession date stated in the SCC.

- (b) The project manager orders a delay or does not issue drawings, specifications, or instructions required for execution of works on time.
- (c) The project manager instructs the contractor to uncover or to carry out tests upon completed work, which is then found to have no defects.
- (d) Other contractors, public authorities, utilities, or the employer cause delay or extra cost to the contractor.
- (e) The advance payment is delayed.
- (f) The project manager unreasonably delays issuing a certificate of completion.
- (g) Any other events as stipulated in the SCC.

If such an event occurs, then the contract price shall be equitably adjusted.

25. Tax

25.1 The contractor is liable for all taxes in accordance with the laws of the employer's country. However, the project manager shall adjust the contract price if taxes, duties, and other levies are changed between the date 28 days before the submission of bids for the contract and the date of the last completion certificate. The adjustment shall be the change in the amount of tax payable by the contractor, provided such charges are already not reflected in the contract price.

26. Liquidated damages

26.1 The contractor shall pay liquidated damages to the employer at the rate per day stated in the SCC for each day that the completion date is later than the required completion date. The total amount of liquidated damages shall not exceed the ceiling amount defined in the SCC. The employer may deduct liquidated damages from any payments due to the contractor. Payment of liquidated damages shall not affect the contractor's liabilities.

27. Advance payments

27.1 The employer shall make advance payment to the Contractor in the amounts stated in the SCC after the contractor has:



- (i) Delivered to the site construction equipment and/or materials for initiating the works, and
- (ii) Submitted the advance payment guarantee.

27.2 The contractor is to use the advance payment only to pay for equipment, materials and other expenses required specifically for carrying out the works. The contractor shall demonstrate that the advance payment has been used in this way by supply of copies of invoices or other documents to the project manager.

27.3 The advance payment shall be repaid by deducting proportionate amounts from payments otherwise due to the contractor. Full recovery of the advance payment shall be made by the time 75% of the value of the works have been certified for payment by the project manager.

28. Retention money

28.1 An amount, specified in the SCC, will be retained from each payment to the contractor as a safeguard for ensuring satisfactory performance of the work. This money will be paid out to the contractor upon fulfilment of the contractor's contractual obligations i.e. within 15 days of the issue by the project manager of the defects liability certificate. Subject to the approval by the employer, the retention money can be released to the contractor at the time of issue of the certificate of completion of the works against submission by the contractor of an unconditional bank guarantee covering the full amount of the retention money.

29. Dayworks

29.1 If applicable, the dayworks rates in the contractor's bid shall be used for small additional amounts of work only when the project manager has given written instructions in advance for additional work to be paid for in that way.

29.2 All work to be paid for as dayworks shall be recorded by the contractor on forms approved by the project manager. Each completed form shall be verified and signed by the project manager within two days of the work being done.

29.3 The contractor shall be paid for dayworks as work is performed subject to obtaining signed dayworks forms.

30. Cost of repairs

30.1 Loss or damage to the works or materials to be

Section VI. General Conditions of Contract

Construction of 30 Nos. of Collective Marketing Centers under MLAMP- Ref. No: MBMA/MLAMP/ISC&ED/109/2024/W-20A/



incorporated in the works between the start date and the end of the defects liability periods shall be remedied by the contractor at the contractor's cost if the loss or damage arises from the contractor's risks, acts or omissions.

31. Completion and taking over

31.1 The contractor shall request the project manager to issue a certificate of completion of the works, and the project manager will issue such a certificate when it determines that the works are satisfactorily completed. The employer shall take over the site and the works within seven days of the project manager's issuing of a certificate of completion.

32. Final account

32.1 The contractor shall supply the project manager with a detailed account of the total amount that the contractor considers payable under the contract before the end of the defects liability period. The project manager shall issue a defects liability certificate and certify any final payment that is due to the contractor within 45 days of receiving the contractor's account if it is correct and complete. If it is not, the project manager shall issue within 30 days a schedule that states the scope of the corrections or additions that are necessary. If the final account is still unsatisfactory after it has been resubmitted, the project manager shall decide on the amount payable to the contractor and issue a payment certificate.

33. Termination action

33.1 The employer or the contractor may terminate the contract if the other party causes a fundamental breach of the contract.

33.2 Fundamental breaches of contract shall include, but shall not be limited to, the following:

- (a) The contractor stops work for 21 days when no stoppage of work is shown on the current Program and the stoppage has not been authorized by the project manager;
- (b) The project manager instructs the contractor to delay the progress of the works, and the instruction is not withdrawn within 30 days and no agreement is reached on payments due contractor for cost of delay;
- (c) The employer or the contractor is made bankrupt or goes into liquidation other than for a reconstruction or amalgamation;
- (d) A payment certified by the project manager is not paid by



the employer to the contractor within 60 days of the date of the project manager's certificate;

- (e) The project manager gives notice that failure to correct a particular defect is a fundamental breach of contract and the contractor fails to correct it within 30 days from the date of such notice issued by the project manager;
- (f) The contractor has delayed the completion of the works by the number of days for which the maximum amount of liquidated damages can be paid, as defined in the SCC.
- (g) The employer determines that the contractor, or any of its sub-contractors, sub-consultants, suppliers, personnel or any agent or affiliate of any of them has, directly or indirectly, engaged in prohibited practices pursuant to GCC 4.

33.3 When either party to the contract gives notice of a breach of contract to the project manager for a cause other those listed under sub-clause 33.2 above, the project manager shall decide whether the breach is fundamental or not.

33.4 Notwithstanding the above, the employer may terminate the contract for convenience by giving the contractor a thirty-day notice in writing.

33.5 If the contract is terminated, the contractor shall stop work immediately, make the site safe and secure, and leave the site within 15 days of the completion of the notice period.

34. Payment upon termination

34.1 If the contract is terminated because of a fundamental breach of contract by the contractor, the project manager shall issue a certificate for the value of the work done and materials ordered less advance payments received up to the date of the issue of the certificate and less the percentage to apply to the value of the work not completed, as indicated in the SCC. Additional liquidated damages shall not apply. If the total amount due to the employer exceeds any payment due to the contractor, the difference shall be a debt payable to the employer.

34.2 If the contract is terminated for the employer's convenience or because of a fundamental breach of contract by the employer, the project manager shall issue a certificate for the



value of the work done, materials ordered, the reasonable cost of removal of equipment, repatriation of the contractor's personnel employed solely on the works, and the contractor's costs of protecting and securing the works, and less advance payments received up to the date of the certificate.

35. Property

35.1 All materials and construction equipment on the site, plant, temporary works, and works shall be deemed to be the property of the employer if the contract is terminated because of the contractor's default.

36. Release from performance

36.1 If the contract is frustrated by the outbreak of war or by any other event entirely outside the control of either the employer or the contractor, the project manager shall certify that the contract has been frustrated. The contractor shall make the site safe and stop work as quickly as possible after receiving this certificate and shall be paid for all work carried out before receiving it and for any work carried out afterwards for which an agreement has been reached.

37. Resolution of disputes

37.1 The employer and the contractor shall make every effort to resolve amicably by direct informal negotiation any disagreement or dispute arising between them under or in connection with the contract. If after thirty (30) days from the commencement of such informal negotiations, the employer and the contractor have been unable to resolve amicably a contract dispute, either party may require that the dispute be referred to arbitration in accordance with the law governing the contract. The place where arbitration will take place will be stated in the SCC.

38. Performance security

38.1 The performance security shall be provided to the employer no later than the date specified in the letter of acceptance and shall be issued in the amount specified in the SCC, in a form and by a bank acceptable to the employer, and denominated in the types and proportions of the currencies in which the contract price is payable. The performance security shall be valid until a date 28 days from the date of issue of the defects liability certificate.



Section VII. Specific Conditions of Contract (SCC)

Section VII. Special Conditions of Contract (SCC)

Construction of 30 Nos. of Collective Marketing Centers under MLAMP- Ref. No: MBMA/MLAMP/ISC&ED/109/2024/W-20A/



Special Conditions of Contract

GC
C
Clau
se
Nu
mbe
r

SCC

1.1 Insert in the SCC the following definitions:

“Contract: The name and procurement number of the contract are

“Construction of 30 Nos. of Collective Marketing Centers (CMCs) under MLAMP”;
NCB-20

“Defects liability period: the defects liability period is 365 [days]

“Employer: the employer is Meghalaya Basin Management Agency (MBMA),
Nongrim Hills, Shillong.

The employer’s country is “India”.

““Required completion date: The intended completion date shall be 3 (three) months
from the date of the commencement of the contract.

“Project manager: The project manager is *“Shri B M Syiem”*

“Site: the site is located at:

Lot#	NAME OF DISTRICT	NAME OF BLOCK	IVCS	GPS Coordinates	
				Latitutde	Longitude
Lot#1	East Jaintia Hills	Khliehriat	Cham Cham IVCS	25.362412	92.232237
		Khliehriat	Samasi IVCS	25.401080	92.546906
		Khliehriat	Byrwai IVCS	25.432862	92.401844
Lot#2	East Khasi Hills	Mawsynram	Mawkasain IVCS	25.265337	91.518527
		Mylliem	Rangbihbih IVCS	25.4983	91.8767
		Mawryngkneng	Mawiong IVCS	25.6793	92.02961
		Mawryngkneng	Puriang IVCS	25.540872	92.09438
		Pynursla	Pynter IVCS	25.26324	91.962562

		Pynursla	Wahkdait IVCS	25.20771	91.987267
		Mawkynrew	Jatah Nonglyer IVCS	25.413687	92.056869
		Mawkynrew	Laitkyrhong IVCS	25.463793	91.899101
		Mawlai	Iaryntihlang FACT IVCS	25.6869066	91.966895
Lot#3	West Khasi Hills	Mawshynrut	Sangriang IVCS	25.465653	91.241434
		Mawshynrut	Nonglwai IVCS	25.461021	91.328049
		Mairang	Nongrmai IVCS	25.616336	91.618149
		Mawshynrut	Seinduli IVCS	25.660837	91.14363
Lot#4	South Garo Hills	Gasuapara	Megua Songma IVCS Ltd.	25.250533	90.288801
		Chokpot	Balwatgre IVCS Ltd.	25.300907	90.442133
		Baghmara	Nongalbibra IVCS	25.46384584	90.70114246
		Gasuapara	Bamonbajra IVCS Ltd.	25.223516	90.482828
Lot#5	South West Garo Hills	Zikzak	Saliram IVCS Ltd.	89.847507	89.847507
Lot#6	South west khasi hills	Mawkyrwat	Iamonlang IVCS	25.27031	91.226228
		Mawkyrwat	Warsanlyngdoh IVCS	25.403933	91.202565
		Mawkyrwat	Tyllilang IVCS	25.230214	91.3205
		Ranikor	Raibah IVCS	25.25321333	91.43435667
		Mawkyrwat	Rangblang Sohsyniang IVCS	25.413654	91.361515
		Mawkyrwat	Shngimawlein Nongbrei Nongdom IVCS	25.422818	91.483656
Lot#7	West Garo Hills	Demdema	Beautiful IVCS Ltd.	25.871012	90.062676
		Demdema	Khurang IVCS Ltd.	25.868377	90.068796
Lot#8	West Jaintia Hills	Amlarem	Padu Bah IVCS	25.277426	92.028419

Start date: the start date shall be 10 (Ten) days after the date of issue of notice to proceed with works to the contractor.

Works: the works consist of: Construction of 30 Nos. of CMCs under MLAMP.

1.2	This contract shall be a unit priced contract based on priced bills of quantities
2.1	The language of the contract is <i>English</i> . The governing law is the law of the employer's country.
6.1	Following are the compliances required by the Contractor for the SECAP:

Section VII. Special Conditions of Contract (SCC)

Construction of 30 Nos. of Collective Marketing Centers under MLAMP- Ref. No: MBMA/MLAMP/ISC&ED/109/2024/W-20A



Environment Aspects or Project Activities	Civil work/ Project activities	Potential Environmental/Social Impacts	Mitigation/ Remedial Measures	Costs	Institutional Responsibility			Frequency of implementation and/or monitoring
					Responsibility	Monitoring Action/ Indicator	Supervision	
Natural Resources	<p>Construction of:</p> <p>1. Construction of CM C with storage: Area is 431 Sq. ft</p> <p>2. Toilet facility: Area is 132 Sq. ft</p>	<p>1. Development happening in areas where little up-to-date information exists on sustainable yield/carrying capacity</p> <p>2. Sub-project rely on surface water</p>	<p>1. The availability of the CMCs in this area will address the problem of carrying capacity and meet the increasing demand in agricultural produce and sustain the livelihood of the people</p> <p>2. The construction of the</p>	Design costs	Contractor ED, Technical MBMA DPMU	<p>1. Assessment on the new infrastructure to be build. To increase the facilities of the infrastructure if there are further requirements</p> <p>2. Availability of water during the construction</p>	ED - Technical MBMA	During the construction phase and after the CMC is operational

Section VII. Special Conditions of Contract (SCC)

Construction of 30 Nos. of Collective Marketing Centers under MLAMP- Ref. No: MBMA/MLAMP/ISC&ED/109/2024/W-20A/



				CMC is at a minor scale and does not cause any depletion and/or reduced flow of ground water and/or surface water				
Climate Change Adaptation	<ol style="list-style-type: none"> 1. Use of climate-resilient design and materials 2. Elevated structures and collection space, drying area, retail area, office space facilities 3. Energy-efficient lighting and appliances 4. Storage facility 	<ol style="list-style-type: none"> 1. During summer the temperature may reached up to 35 deg. C 2. Heavy rainfall is expected during the monsoon season 	<ol style="list-style-type: none"> 1. Construction of a storage and drying area facility is part of the sub-project. Hence cold storages may be installed in future as per the requirements 2. The 	Design costs	<ol style="list-style-type: none"> 1. ED, Technical - MBMA 2. Contractor 3. DPMU - MLAMP 	<ol style="list-style-type: none"> 1. Regular inspection of materials and infrastructures 	ED - Technical / MBMA	Prior and during the construction phase

Section VII. Special Conditions of Contract (SCC)

Construction of 30 Nos. of Collective Marketing Centers under MLAMP- Ref. No: MBMA/MLAMP/ISC&ED/109/2024/W-20A/



				roof of the infrastructure will be a slanting-type design so that water will not be accumulated during rainy season					
Human Rights	1. Fair labour practices 2. Accessibility for all vendors and customers	1. Labor exploitation 2. Discrimination	1. Implement fair wage policies 2. Ensure accessibility for people with disabilities	Design cost	1. IVCS committee	1. Labor audits 2. Accessibility checks	1. DP MU - MB MA 2. IVC S Committee	Prior and during the construction phase and after the market is operational	
Health and Safety	1. Safe construction practices 2. Health facilities for market users	Occupational health and safety hazards to construction personnel & public	1. Provide safety training and equipment 2. Ensure availability of health	Design cost	1. Contractor 2. MLAMP - DPMU	1. Incident reports 2. Health service utilization	1. Contractor 2. MLA MP - DPMU	Prior and during the construction phase and after the market is operational	

Section VII. Special Conditions of Contract (SCC)

Construction of 30 Nos. of Collective Marketing Centers under MLAMP- Ref. No: MBMA/MLAMP/ISC&ED/109/2024/W-20A/



				services					
7.1	sub-contracting is not allowed								
8.1	<p>The schedule of key personnel are:</p> <ol style="list-style-type: none"> 1. Project Site Manager 2. Environmental specialist 3. Social specialist 4. Site Engineer 5. Quantity Surveyor 6. Supervisor 7. Health and Safety Officer 								
10.1	<p>The minimum insurance covers shall be:</p> <ol style="list-style-type: none"> (a) The minimum insurance cover for the loss of or damage to the works, equipment and materials shall be equal to the contract value and the materials as per the contract price with a maximum deductible for each insurance claim of of Rs 1.00 Lakhs (b) The minimum insurance cover for loss of or damage to property (except the works, plant, materials and equipment) is Rs 5.00 Lakhs with a maximum deductible of Rs 1.00 Lakhs. (c) The minimum insurance cover for personal injury or death and third-party liability is Rs 5.00 Lakhs with no deductible. 								
12.1	<p>The site possession date shall be within 15 days of commencement date. The start date is: 10 days after the date of issue of notice to proceed with works to the contractor.</p>								
14.1	<p>The period for submission of the program is 15 days from the date of signature of agreement. The period between the program updates is 90 days.</p>								

Section VII. Special Conditions of Contract (SCC)

Construction of 30 Nos. of Collective Marketing Centers under MLAMP- Ref. No: MBMA/MLAMP/ISC&ED/109/2024/W-20A/



26.1	<p>The liquidated damages for the whole of the works are 1/2000 of the final contract price per day.</p> <p>The maximum amount of liquidated damages for the whole of the works is 10% (Ten) percent of the final contract price.</p>
27.1	<p>The Mobilization advance payment will be 10% (Ten) percent of the Initial contract price on submission of Irrevocable Bank Guarantee and after obtaining confirmation from the issuing bank.</p>
28.1	<p>The amount of retention money will be 5% of each payment due to the contractor up to the maximum of 5% of the total contract amount.</p>
34.1	<p>The percentage to apply to the value of the works not completed, representing the employer's additional cost for completing the works is 20% (Twenty) percent.</p>
36.1	<p>The procedure for adhoc arbitration will be as follows:</p> <p>(a) In case of Dispute or difference arising between the Employer and an Indian Contractor relating to any matter arising out of or connected with this agreement, such disputes or difference shall be settled in accordance with the Arbitration and Conciliation Act, 1996, Amendment 2015 & 2019. The arbitral tribunal shall consist of 3 Arbitrators one each to be appointed by the Employer and the Contractor. The third Arbitrator shall be chosen by the two Arbitrators So appointed by the Parties and shall act as Presiding Arbitrator. In case of failure of the two Arbitrators appointed by the parties to reach upon a consensus within a period of 30 days from the appointment of the Arbitrator appointed subsequently, the Presiding Arbitrator shall be Appointed by the Chairman, Institution of Engineers, (India), Shillong, Meghalaya. For the purposes of this Sub-Clause, the term –Indian Contractor means a contractor who is registered in India and is a juridical person created under Indian law</p> <p>(b) If one of the parties fails to appoint its Arbitrator in pursuance of sub clause (a) Above within 30 days after receipt of the notice of the appointment of its Arbitrator by the other party, then the Chairman, Institution of Engineers, (India), Shillong, Meghalaya, shall appoint the Arbitrator. A certified copy of the order of the Chairman, Institution of Engineers, (India), Shillong, Meghalaya making such an appointment shall be furnished to each of the parties.</p> <p>(c) Arbitration may be commenced prior to or after completion of the Works, provided that the obligations of the Employer, the Project Manager, the Contractor and the Adjudicator shall not be altered by reason of the arbitration being conducted during the progress of the Works.</p>



(d) IFAD Right to Observe: IFAD has the right to be an observer to any arbitration proceeding associated with this contract, at its sole discretion, but does not have the obligation to participate in any arbitration proceeding. Whether or not IFAD is an observer to any arbitration associated with this contract, the parties shall provide IFAD with written English transcripts of any arbitration proceedings or hearings and a copy of the reasoned written award within ten (10) days after (a) each such proceeding or hearing or (b) the date on which any such award is issued. IFAD may enforce its rights under this contract in an arbitration conducted in accordance with this provision. The acceptance by IFAD of the right to be an observer to the arbitration shall not constitute consent to the jurisdiction of the courts or any other body of any jurisdiction or to the jurisdiction of any arbitral panel.

(e) Arbitration proceedings shall be held at Shillong, India, and the language of the arbitration proceedings and that of all documents and communications between the parties shall be English.

(f) The decision of the majority of Arbitrators shall be final and binding upon both parties. The cost and expenses of Arbitration proceedings as also the fees and expenses paid to the Arbitrators will be paid equally by both the parties. However, the expenses incurred by each party in connection with the preparation, presentation, etc. of its proceedings on its behalf shall be borne by each party itself.

(g) Where the value of the contract is Rs.50 million and below, the disputes or differences arising shall be referred to the Sole Arbitrator. The Sole Arbitrator should be appointed by agreement between the parties; failing such agreement, by the Chairman, Institution of Engineers, (India), Shillong, Meghalaya.

(h) The Arbitrator should give final award within the time limit prescribed in Arbitration and Conciliation Act, 1996, amendment 2015 & 2019.

(i) Performance under the contract shall continue during the arbitration proceedings and payments due to the contractor by the Employer shall not be withheld, unless they are the subject matter of the arbitration proceedings.

Any dispute or difference whatsoever arising between the parties out of or relating to the construction, meaning, scope, operation or effect of this contract or the validity or

	the breach thereof shall be settled by arbitration in accordance with the Arbitration and Conciliation Act, 1996, amendment 2015 & 2019 and the award made in pursuance thereof shall be binding on the parties
37.1	<p>The performance security amount is 5%(five) percent of the total contract price in the form of "Irrevocable Bank Guarantee"</p> <p>The Performance Security shall be provided to the Employer no later than the date specified in the Letter of Acceptance and shall be issued in the amounts specified in the PCC (for GCC 50.1), and shall be issued by a Nationalized or Scheduled bank in India.</p>

Section VII. Special Conditions of Contract (SCC)

Construction of 30 Nos. of Collective Marketing Centers under MLAMP- Ref. No: MBMA/MLAMP/ISC&ED/109/2024/W-20A/



Works Requirements

The works requirements include:

- (a) the Specifications (Section VIII)
- (b) the Drawings (Section IX)
- (c) the Bill of Quantities OR Activity Schedules (Section X) and Daywork Schedules, if applicable.



Section VIII. Specifications

1. FOR CIVIL WORKS: MEGHALAYA PUBLIC WORKS DEPARTMENT
(BUILDINGS) SPECIFICATIONS 2021 - 2022

2. FOR ELECTRICAL WORKS: MEGHALAYA PUBLIC WORKS DEPARTMENT
(BUILDINGS) SPECIFICATIONS FOR ELECTRICAL WORKS 2021 - 2022



Section IX. Drawings

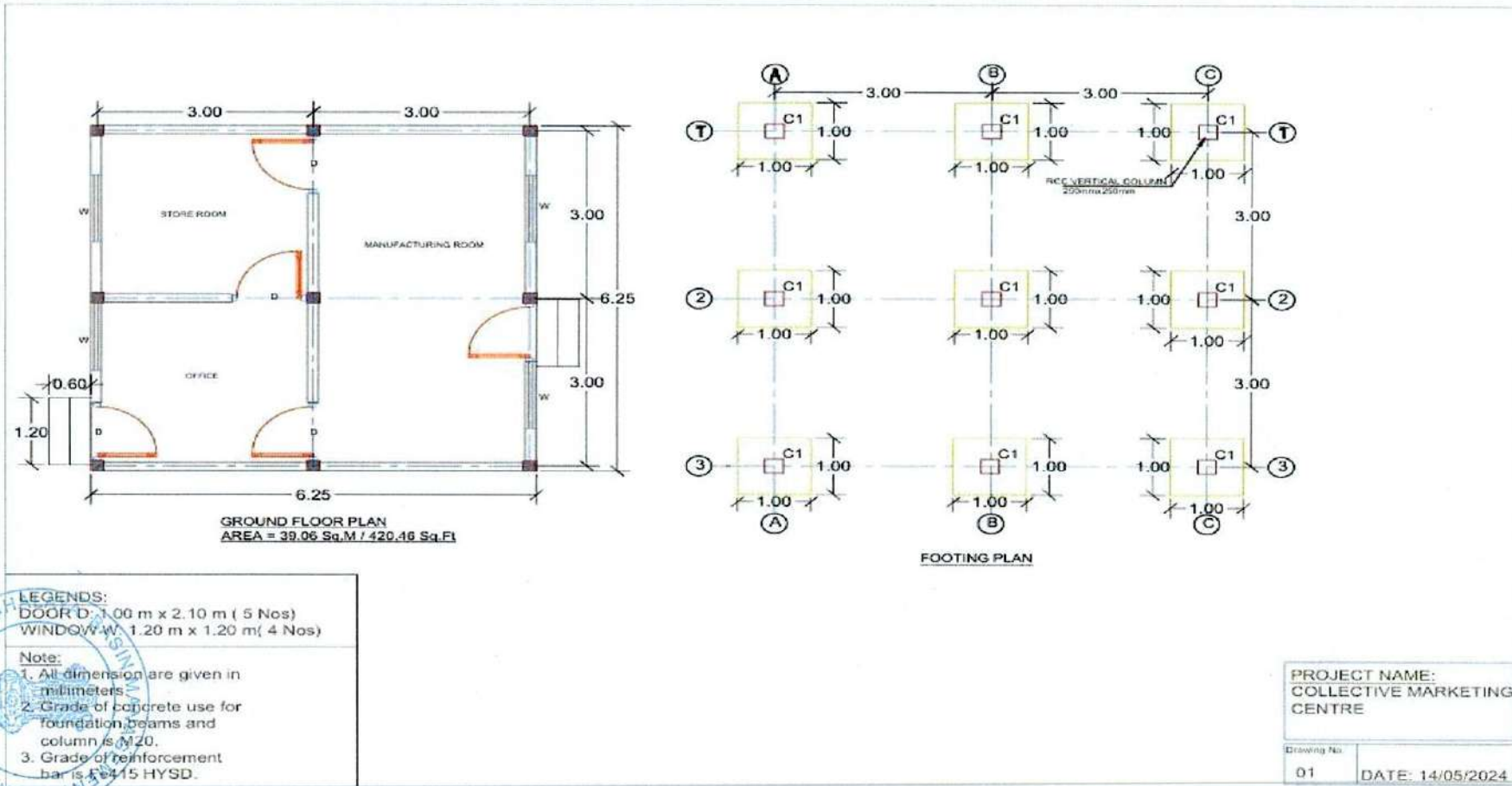

Section VIII. Specifications

Construction of 30 Nos. of Collective Marketing Centers under MLAMP- Ref. No: MBMA/MLAMP/ISC&ED/109/2024/W-20A/



Section VIII. Specifications

Construction of 30 Nos. of Collective Markiting Centers under MLAMP- Ref. No: MBMA/MLAMP/ISC&ED/109/2024/W-20A/

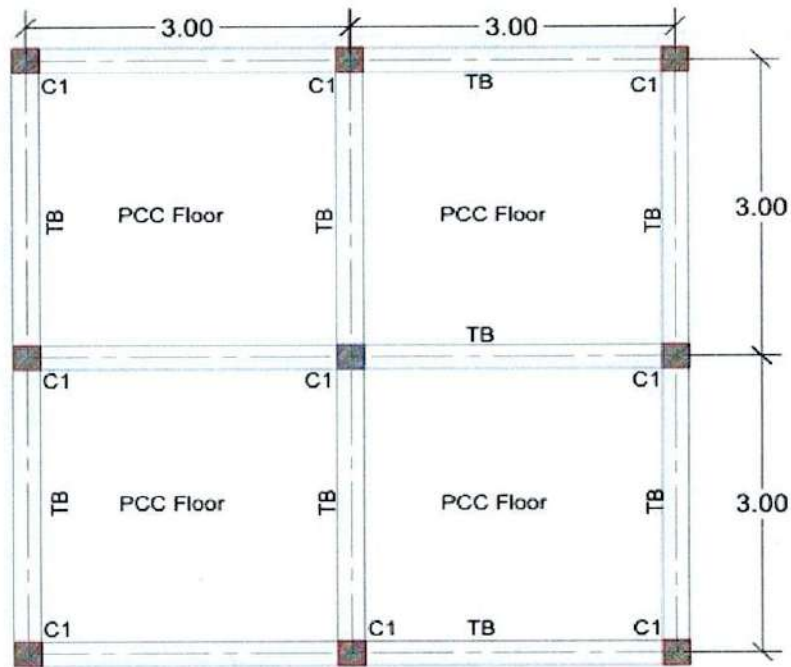

GROUND FLOOR PLAN

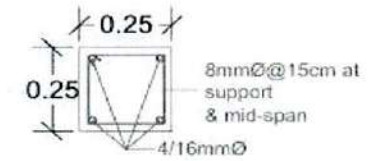

Section of All Column C1

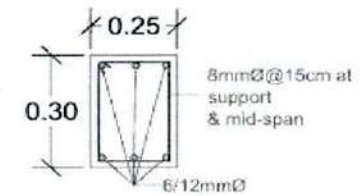

Section of Tie Beam at Ground Level

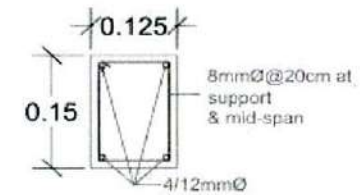

Section of Lintel at Roof Level



PROJECT NAME:
COLLECTIVE MARKETING
CENTRE

Drawing No.

02

DATE: 14/05/2024

Section VIII. Specifications

Construction of 30 Nos. of Collective Marketing Centers under MLAMP- Ref. No: MBMA/MLAMP/ISC&ED/109/2024/W-20A/

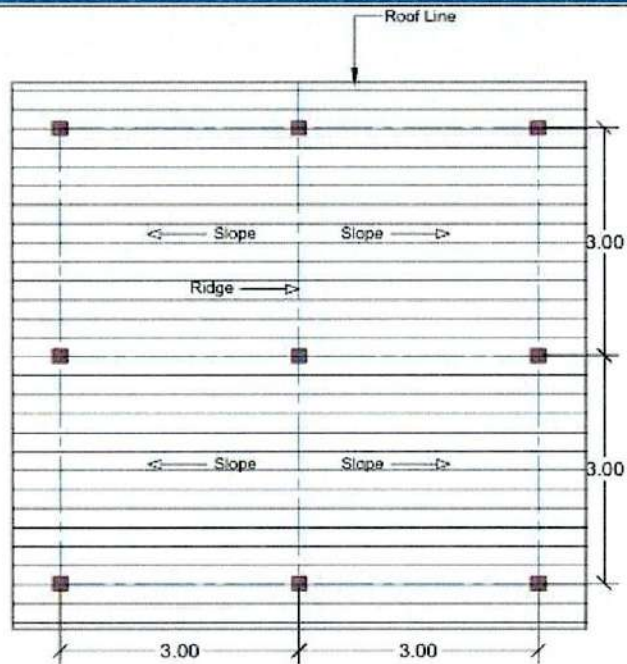

ROOF PLAN WITH CGI SHEET OR DYNA

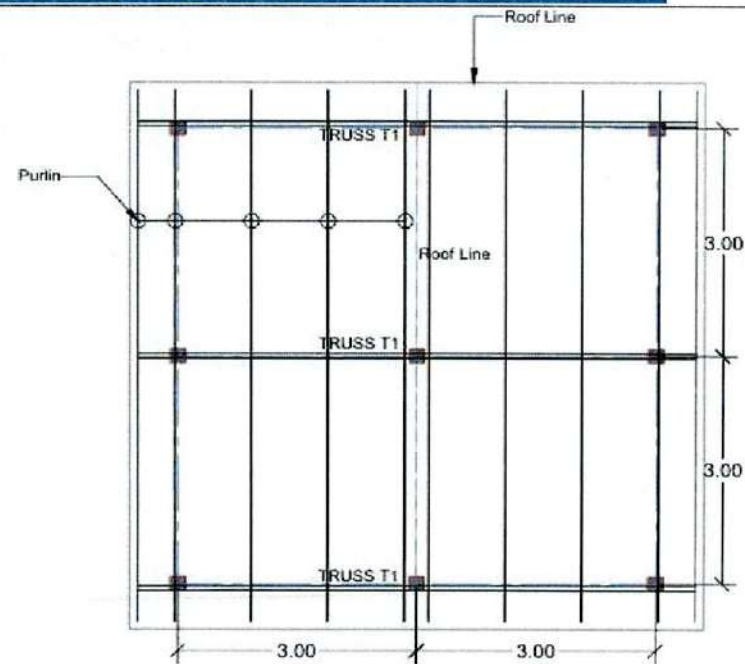

ROOF TRUSS PLAN

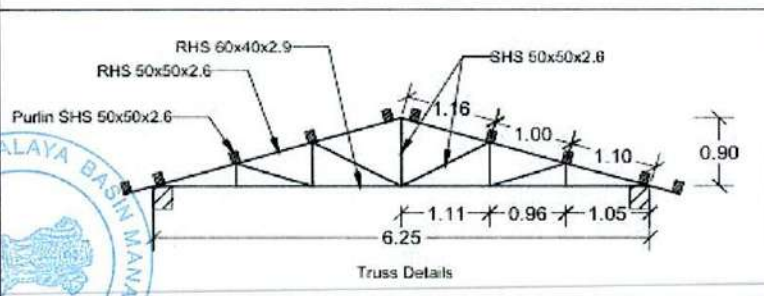

Truss Details

PROJECT NAME:
COLLECTIVE MARKETING
CENTRE

Drawing No.
03 DATE: 14/05/2024



Section VIII. Specifications

Construction of 30 Nos. of Collective Marketing Centers under MLAMP- Ref. No: MBMA/MLAMP/ISC&ED/109/2024/W-20A/

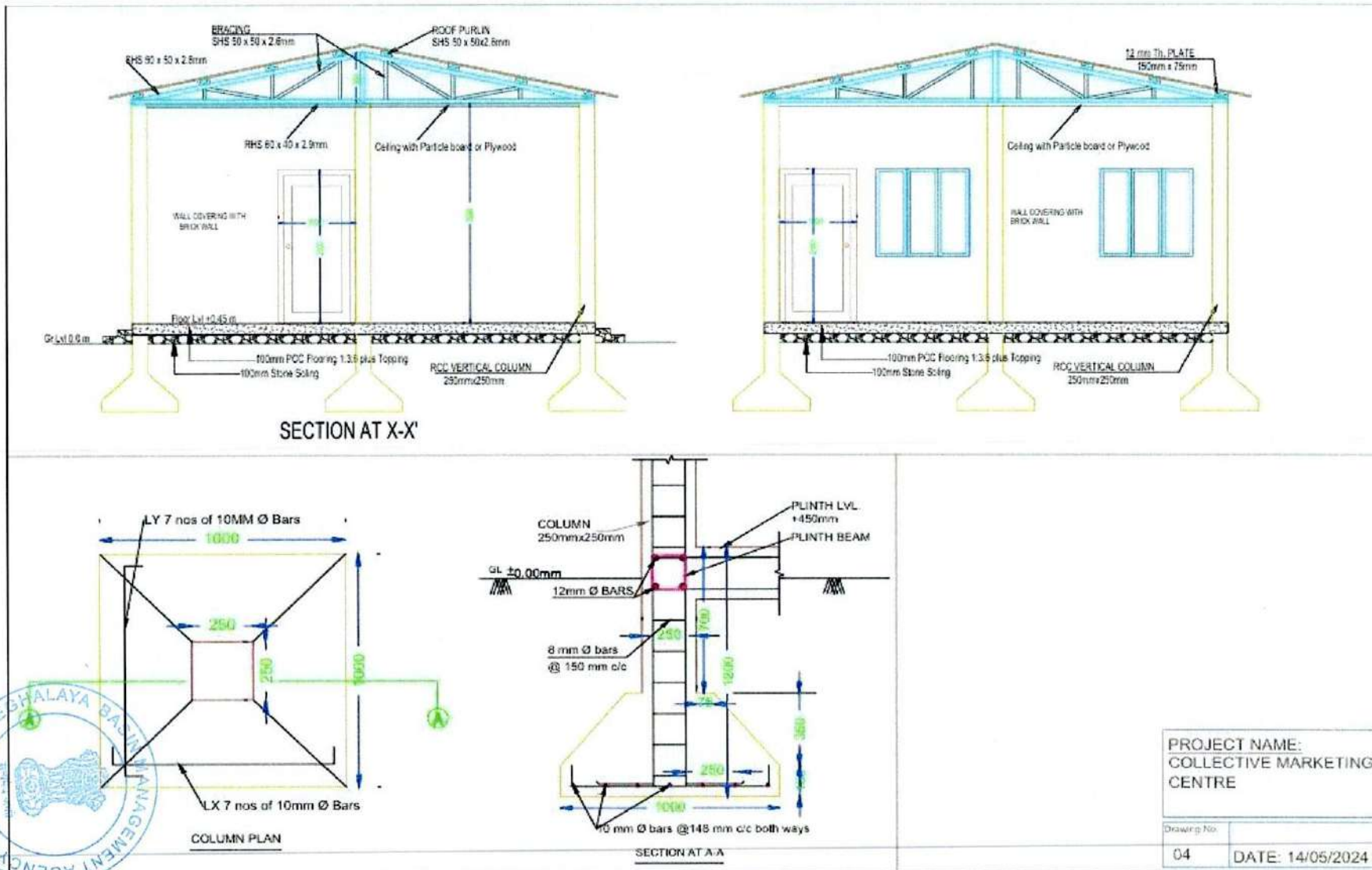

PROJECT NAME: COLLECTIVE MARKETING CENTRE	
Drawing No:	
04	DATE: 14/05/2024



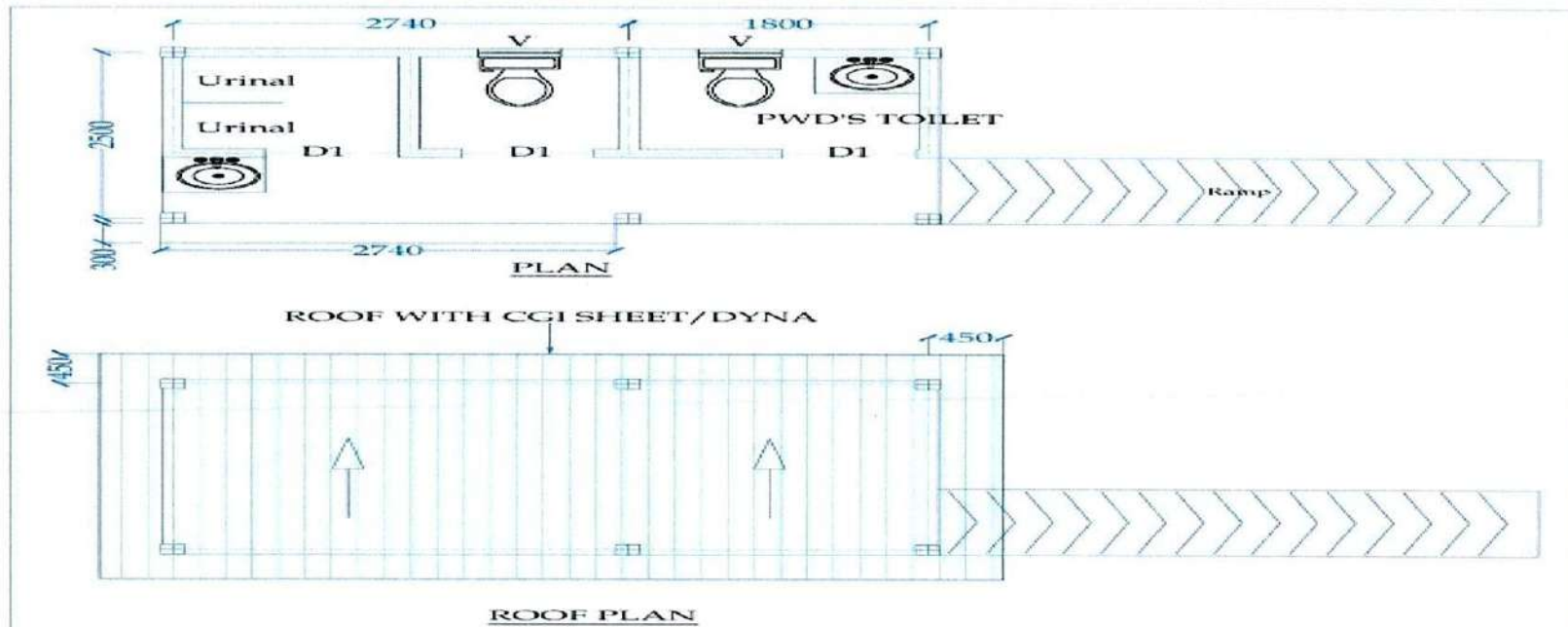

SCHEDULE:
D1- 0.80mX1.10m (Steel doors)
V- 0.50mX0.45m (Steel Ventilators)

Note:
1. All dimensions are given in millimetres.
2. Drawings are not to be scale
3. Grade of concrete use for foundation, columns and lital beams is M15.
4. Grade of bar use for reinforcement is Fe500 (FYSD).

Section VIII. Specifications

Construction of 30 Nos. of Collective Markiting Centers under MLAMP- Ref. No: MBMA/MLAMP/ISC&ED/109/2024/W-20A/

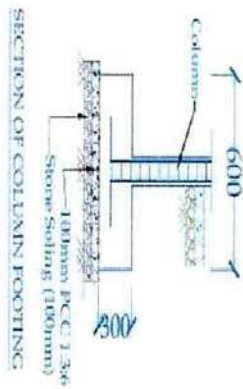
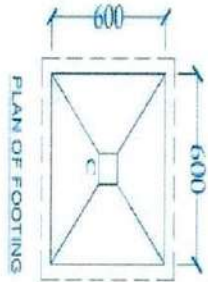
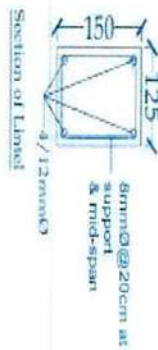
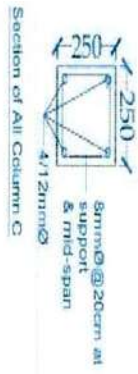
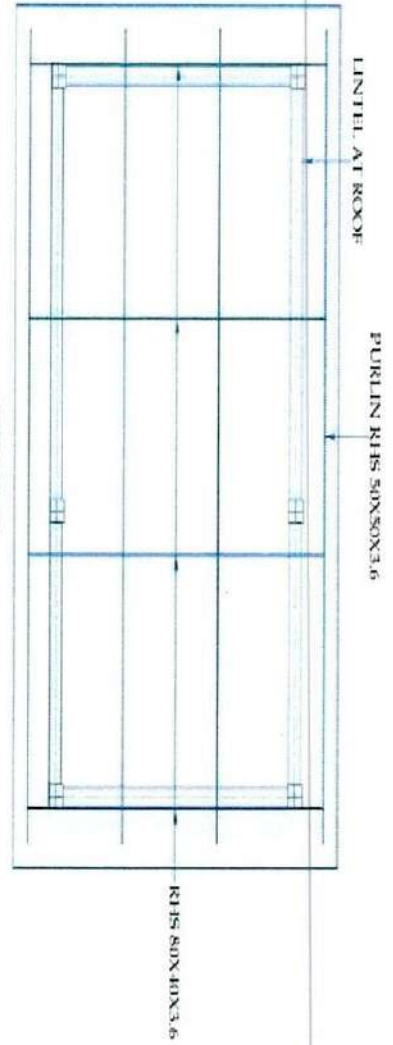

- Note:
1. All dimensions are given in millimetres.
 2. Drawings are not to be scale.
 3. Grade of concrete use for foundation, column and lint beams is M15.
 4. Grade of bar use for reinforcement is Fe-500 HYSD.



Section VIII. Specifications

Construction of 30 Nos. of Collective Markiting Centers under MLAMP- Ref. No: MBMA/MLAMP/ISC&ED/109/2024/W-20A/

Section X. Bill of Quantities OR Activity Schedule

[In addition, if dayworks are foreseen, then indicative quantities of labour, materials and equipment time must be filled in the following dayworks schedules by the employer. They are to be priced by the bidder.]

A. GENERAL ABSTRACT PROPOSED CONSTRUCTION OF CMC

Sl. No.	Brief Description	Total Amount
1	Cost of Construction of CMC with Brick	
2	Cost of Construction of Toilet with Brick	
3	Sub-Total A	
4	Cost of Septic Tank and soak pit for 15 users (as per Plinth area rates)	
5	Add:Cost of External & Internal Water Supply and sanitary fittings	
6	Add:Cost of Internal Electrification	
7	Sub-Total B	
8	Add: Contingencies	
9	Total Cost	

Section VIII. Specifications

Construction of 30 Nos. of Collective Marketing Centers under MLAMP- Ref. No: MBMA/MLAMP/ISC&ED/109/2024/W-20A



Name of Work : Construction of Collective Marketing Centers (CMCs) in different parts of Meghalaya.

CONSTRUCTION OF COLLECTIVE MARKETING CENTRE

Sl. No./ Item No.	Particulars	Qty	Unit	Rate	Amount (Rs)
1	Earthwork in excavation by Mechanical means up to a depth of 2 m below the existing ground level for foundation, trenches of foundations, footings of column/ walls, retaining walls, septic tank etc. including bailing out water where necessary and removal of surplus earth with all lead and lifts as directed and specified for the following classification of soils. (a) All kinds of soil (ordinary soil/ hard soil/ dense soil)	18.14	Cu m		
2	Earthwork in filling (excluding rock) in trenches, plinth, sides of foundation etc in layers not exceeding 20 cm thick including breaking of clods, consolidating each layer by ramming and watering, lead up to 50 m and lift up to 1.5 m . a.) With available excavated earth	18.92	Cu m		
3	Providing soling with stone/ best quality picked jhama brick, sand packed and laid to level and in panel after preparing the subgrade as directed including all labour and materials and if necessary dewatering, complete				
4	Stone soling 100 mm	62.41			
5	Plain cement concrete works in foundation bed for footing steps, walls, brick works etc below plinth level as directed and specified including dewatering if necessary, and curing complete (shuttering where necessary shall be measured and paid separately) b 1:3:6 (1 Cement: 3 coarse sand: 6 graded stone aggregate 20 mm nominal size)	1.79	Cu m		
6	Plain cement concrete floor base in prop 1:3:6 laid in alternate bays as specified with coarse aggregate of size 13 mm to 32mm including dewatering if necessary, and curing etc. complete. (c) 100 mm thick in prop 1:3:6	40.86	Sq. m		

Section VIII. Specifications

Construction of 30 Nos. of Collective Marketing Centers under MLAMP- Ref. No: MBMA/MLAMP/ISC&ED/109/2024/W-20A



7	Random rubble masonry with hard stone in foundation and plinth including levelling up with cement concrete 1:6:12 (1 cement: 6 coarse sand: 12 graded stone aggregate 20 mm nominal size) up to plinth level with: a Cement mortar 1:6 (1 cement: 6 coarse sand) (a) Random Rubble Masonry	5.15	Cu m		
8	Centering and shuttering including strutting, propping etc. and removal of form for all heights complete and as directed by Engineer in charge (a) Foundation, footings, bases of columns, pile cap, raft and mass concrete works etc.	11.7	Sq. m		
9	Lintels, beams, plinth beams, girders, brusses and cantilevers (using steel)	32.40	Sq. m		
10	Centering and shuttering including strutting, propping etc. and removal of form for all heights complete and as directed by Engineer :				
11	Columns, Pillars, Piers, Abutments Posts & Strut (using steel)	13.50	Sq.m		
12	Supplying, fitting and fixing in position reinforcement bars up to 1st floor level, conforming to relevant I.S. Code for R.C.C. work/ R.B. walling including straightening, cleaning, cutting and bending to proper shapes and length as per details, supplying and binding with 20 G annealed black wire and placing in position with proper blocks, supports, chairs, spacers etc. complete. (Rates inclusive of all wastage, lapping, hooks, chairs, anchorage etc. and no measurement for the same is required) b High Yield Strength Deformed bars or Tor Bars	9.27	Qntls		
13	Providing and laying in position specified grade of reinforced cement concrete, excluding the cost of centering, shuttering, finishing and reinforcement- All work up to plinth level: (b) M20 or Prop. 1:11/2:3	6.95	Cum		
14	Reinforced Cement Concrete work in walls columns	1.69	Cum		

Section VIII. Specifications

Construction of 30 Nos. of Collective Marketing Centers under MLAMP- Ref. No: MBMA/MLAMP/ISC&ED/109/2024/W-20A/



	excluding cost of centering, shuttering, finishing form work and reinforcement. (b) M20 or Prop. 1:11/2:3				
15	Steel work in built up tubular (round, square or rectangular hollow tubes etc.) trusses etc., including cutting, hoisting, fixing in position and applying a priming coat of approved steel primer, including welding and bolted with special shaped washers etc. complete.	510.06	Kg		
16	Providing and fixing pre-coated galvanised iron profile sheets (size, shape and pitch of corrugation as approved by Engineer-in-charge) 0.50 mm(+0.05 %) total coated thickness with zinc coating 120 grams per sqm as per IS:277, in 240 MPa steel grade, 5-7 microns epoxy primer on both side of the sheet and polyester top coat 15-18 microns. Sheet should have protective guard film of 25 microns minimum to avoid scratches during transportation and should be supplied in single length up to 12 meter or as desired by Engineer-in-charge. The sheet shall be fixed using self-drilling/self tapping screws of size (5.5x55 mm) with EPDM seal, complete up to any pitch in horizontal/ vertical or curved surfaces, excluding the cost of purlins, rafters and trusses and including cutting to size and shape wherever required.	54.00	Sq.m		
17	Providing and fixing pre-coated galvanised steel sheet roofing accessories 0.50 mm (+0.05 %) total coated thickness, Zinc coating 120 grams per sqm as per IS:277, in 240 MPa Steel grade, 5-7microns epoxy primer on both side of the sheet and polyester top coat 15-18 microns using self-drilling/ self tapping screws complete: a) Ridges plain (500- 600mm)	7.2	Rm		
18	Providing and fixing pre-coated galvanised steel sheet roofing accessories 0.50 mm (+0.05 %) total coated thickness, Zinc coating 120 grams per sqm as per IS:277, in 240 MPa Steel grade, 5-7microns	28.80	Rm		



Section VIII. Specifications

Construction of 30 Nos. of Collective Marketing Centers under MLAMP- Ref. No: MBMA/MLAMP/ISC&ED/109/2024/W-20A/

	epoxy primer on both side of the sheet and polyester top coat 15-18 microns using self-drilling/ self tapping screws complete: f) Gutter (600 mm over all girth)				
19	Half brick masonry with common burnt clay (non modular) 1st class bricks in superstructure above plinth level up to first floor level. (b) Cement mortar 1:4 (1 cement: 4 coarse sand)	88.14	Sq.m		
20	15 mm cement plaster on the rough side of single or half brick wall of mix: a) In cement mortar 1:4	179.73	Sq.m		
21	Applying one coat of water thinnable cement primer of approved brand and manufacture on wall surface : 13.43.1) Water thinnable cement primer	179.73	Sq.m		
22	Distemping with 1st quality acrylic distemper (ready mixed) having VOC content less than 50 gms/litre, of approved manufacturer, of required shade and colour complete, as per manufacturer's specification. 13.42.1 Two or more coats on new work	108.24	Sq.m		
23	Finishing walls with water proofing cement paint of required shade : 13.44.1 New work (Two or more coats applied @ 3.84 kg/10 sqm)	76.29	Sq.m		
24	Providing wood work in frames of doors, windows, clerestory windows and other frames, wrought framed and fixed in position with hold fast lugs or with dash fasteners of required diameter & length. (c) With 1st Class Local wood (i) Pooma/ Hollock/ Gamari/ and the like	0.20	Cum		
25	Providing and fixing ISI marked flush door shutters conforming to IS:2202 (Part I) decorative type, core of block board construction with frame of 1st class hard wood and well matched teak 3 ply	10.50	Sq.m		



Section VIII. Specifications

Construction of 30 Nos. of Collective Marketing Centers under MLAMP- Ref. No: MBMA/MLAMP/ISC&ED/109/2024/W-20A/

	veneering with vertical grains or cross bands and face veneers on both faces of shutters. (a) 35 mm thick including ISI marked Stainless Steel butt hinges with necessary screws				
26	Applying priming coat: a) With ready mixed pink or Grey primer of approved brand and manufacture on wood work (hard and soft wood)/ with ready mixed aluminium primer of approved brand and manufacture on resinous wood and plywood	63.93	Sq.m		
27	Painting two coats (excluding priming coat) on new wood and wood based surface with enamel paint of approved brand and manufacture (Asian paint/ Berger paint/ ICI paint/ J & N paint/ Nerolac) to give an even shade including cleaning the surfaces of all dirt, dust and other foreign matter sand papering and stopping. (a) Surfaces over 100mm in width or girth. (i) General purpose (Asian paint/ Berger paint/ ICI paint/ J & N paint/ Nerolac).	63.93	Sq.m		
28	Providing, fitting and fixing steel windows (including ventilators) of standard rolled steel sections as per relevant I.S. Code, joints mitred and welded with 15x3x100 mm lugs embedded in cement concrete block of M-10 grade including providing and fixing of projecting hinges (not more than 65mm and not less than 15 mm wide) bolting device, steel handles, pegs, stays of 300 mm long etc. complete including providing 12x12 mm square bars duly welded to steel frame at not more than 12 cm c/c applying a priming coat of red-lead paint etc. complete as per drawing. a) Openable	5.76	Sq.m		
29	Providing & fixing glass panes with putty and glazing clips in steel doors, windows, clerestory	5.76	Sq.m		

Section VIII. Specifications

Construction of 30 Nos. of Collective Marketing Centers under MLAMP- Ref. No: MBMA/MLAMP/ISC&ED/109/2024/W-20A/



	windows, all complete with: b) 5.5 mm thick glass panes				
30	Applying priming coat: b) With ready mixed red oxide zinc chromate primer of approved brand and manufacture on steel galvanised iron/ steel works.	7.66	Sq.m		
31	Finishing with Deluxe Multi surface paint system for interiors and exteriors using Primer as per manufacturers specifications, including scaffolding: c) Painting Steel work with Deluxe Multi Surface Paint to give an even shade. Two or more coat applied @ 0.90 ltr/10 sqm over an under coat of primer applied @ 0.80 ltr/10 sqm of approved brand and manufacture	7.66	Sq.m		
32	Cement concrete floor topping 1:1:2 (1 cement: 1 coarse sand: 2 stone aggregate) finished with a floating coat of neat cement, including cement slurry, complete. b 20 mm thick	41.31	Sq.m		
33	Making plinth protection 50mm thick of cement concrete 1:3:6 (1 cement: 3 coarse sand: 6 graded stone aggregate 20 mm nominal size) over 75 mm thick bed of dry brick ballast 40 mm nominal size, well rammed and consolidated and grouted with fine sand, including necessary excavation, levelling & dressing & finishing the top smooth.	15.00	Sq.m		
34	Providing wood work in frames of false ceiling, partitions, etc. sawn and fixed in position with necessary stainless steel screws etc.c With 1st Class Local wood (i) Pooma/ Hollock/ Gamari and the like	0.24	Cum		
35	Providing and fixing flat pressed 3 layer medium density particle board or graded particle board	36.00	Sq.m		

Section VIII. Specifications

Construction of 30 Nos. of Collective Marketing Centers under MLAMP- Ref. No: MBMA/MLAMP/ISC&ED/109/2024/W-20A/



	(Grade I) IS:3087 marked, in ceiling with necessary nails etc. complete (framework to be paid separately): a 12 mm thick				
		Grand Total =			

BILL OF QUANTITIES: PROPOSED CONSTRUCTION OF TOILET.

Sl. No./ Item No.	Particulars	Qty	Unit	Rate	Amount (Rs.)
1	Earthwork in excavation by manual means up to a depth of 2m below the existing ground level for foundation trenches of foundations, footings of column/ walls, retaining walls, septic tank etc. including bailing out water where necessary and removal of surplus earth with all lead and lifts as directed and specified for the following classification of soils.				
	a All kinds of soil (ordinary soil/ hard soil/ dense soil)l	2.36	m ³		
2	Providing soling with stone/ best quality picked jhama brick, sand packed and laid to level and in panel after preparing the subgrade as directed including all labour and materials and if necessary dewatering, complete.	18.69	m ²		
	b Stone soling (i) 100 mm				
3	Random rubble masonry with hard stone in foundation and plinth including levelling up with cement concrete 1:6:12 (1 cement: 6 coarse sand: 12 graded stone aggregate 20 mm nominal size) up to plinth level with:	1.77	m ³		
	a Cement mortar 1:6 (1 cement: 6 coarse sand)				



Section VIII. Specifications

Construction of 30 Nos. of Collective Marketing Centers under MLAMP- Ref. No: MBMA/MLAMP/ISC&ED/109/2024/W-20A/

4	65 mm thick cement concrete flooring with concrete hardener topping, under layer 50 mm thick cement concrete 1:2:4 (1 cement: 2 coarse sand: 4 graded stone aggregate 20 mm nominal size) and top layer 15 mm thick cement hardener consisting of mix 1:2 (1 cement hardener mix: 2 graded stone aggregate, 6 mm nominal size) by volume, hardening compound mixed @ 2 litre per 50 kg of cement or as per manufacture's specifications. This includes cost of cement slurry, complete.	15.68	m ²		
5	Providing and laying in position specified grade of reinforced cement concrete, excluding the cost of centering, shuttering, finishing and reinforcement- All work up to plinth level: a M15 or Prop. 1:2:4 (1 cement: 2 coarse sand: 4 graded stone aggregate 20 mm nominal size)	0.54	m ³		
6	Reinforced cement concrete work in walls (any thickness), including attached pilasters, buttresses, fillets, columns, pillars, posts and struts etc. above plinth level up to first floor level, excluding cost of centering, shuttering, finishing and reinforcement: a M15 or Prop. 1:2:4 (1 cement: 2 coarse sand: 4 graded stone aggregate 20 mm nominal size)	0.38	m ³		
7	Reinforced cement concrete work in beams, slabs, roofs having slope up to 15°, landings, balconies, shelves, chajjas, lintels, bands, plain window sills, staircases and spiral stair cases above plinth level up to first floor level, excluding the cost of centering, shuttering, finishing and reinforcement. a M15 or Prop. 1:2:4 (1 cement: 2 coarse sand: 4 graded stone aggregate 20 mm nominal size)	0.56	m ³		
8	Earthwork in filling (excluding rock) in trenches, plinth, sides of foundation etc in layers not exceeding 20 cm thick including breaking of clods, consolidating each layer by ramming and watering, lead up to 50 m and lift up to 1.5 m.	1.44	m ³		



Section VIII. Specifications

Construction of 30 Nos. of Collective Marketing Centers under MLAMP- Ref. No: MBMA/MLAMP/ISC&ED/109/2024/W-20A/

	a With available excavated earth				
9	Sand filling in plinth in layers not exceeding 150 mm thick including breaking of clods, consolidating by ramming and watering complete as directed (maximum depth 45 cm).	1.52	m3		
10	Foundations, footings, bases of columns, etc. for mass concrete (using steel).	1.80	m2		
11	Columns, Pillars, Piers, Abutments, Posts and Struts (using steel).	10.80	m2		
12	Lintels, beams, plinth beams, girders, bressumers and cantilevers (using steel).	18	m2		
13	Half brick masonry with common burnt clay (non modular) 1st class bricks in superstructure above plinth level up to first floor level.b Cement mortar 1:4 (1 cement: 4 coarse sand)	41.97	m2		
14	12 mm cement plaster of mix: a 1:4 (1 cement: 4 fine sand)	93.03	m2		
15	White washing with lime to give an even shade: a New work (three or more coats)	93.03	m2		
16	Providing and fixing 1 mm thick M.S. sheet door with frame of 40x40x6 mm angle iron and 3 mm M.S. gusset plates at the junctions and corners, all necessary fittings complete, including applying a priming coat of approved steel primer. a Using M.S. angels 40x40x6 mm for diagonal braces	5.04	m2		
17	Providing, fitting and fixing steel windows/ ventilators (fixed) of standard rolled steel sections as per relevant I.S. Code, joints mitred and welded with 15x3x100 mm lugs embedded in cement concrete block of M-10 grade including applying a coat of red-lead primer.	0.45	m2		



Section VIII. Specifications

Construction of 30 Nos. of Collective Marketing Centers under MLAMP- Ref. No: MBMA/MLAMP/ISC&ED/109/2024/W-20A/

18	Applying priming coat: c With ready mixed red oxide zinc chromate primer of approved brand and manufacture on steel work (second coat)	13.41	m2		
19	c Painting Steel work with Deluxe Multi Surface Paint to give an even shade. Two or more coat applied @ 0.90 ltr/10 sqm over an under coat of primer applied @ 0.80 ltr/10 sqm of approved brand and manufacture	13.41	m2		
20	Providing & fixing glass panes with putty and glazing clips in steel doors, windows, clerestory windows, all complete with: a 4.0 mm thick glass panes	0.45	m2		
21	Steel work in built up tubular (round, square or rectangular hollow tubes etc.) trusses etc., including cutting, hoisting, fixing in position and applying a priming coat of approved steel primer, including welding and bolted with special shaped washers etc. complete.	290.10	kg		
22	Supplying, fitting and fixing in position reinforcement bars up to 1st floor level, conforming to relevant I.S. Code for R.C.C. work/ R.B. walling including straightening, cleaning, cutting and bending to proper shapes and length as per details, supplying and binding with 20 G annealed black wire and placing in position with proper blocks, supports, chairs, spacers etc. complete. (Rates inclusive of all wastage, lappage, hooks, chairs, anchorage etc. and no measurement for the same is required) b High Yield Strength Deformed bars or Tor Bars	2.39	Qntl		
23	Providing corrugated G.S or galvanised iron sheet roofing including vertical/ curved surface fixed with polymer coated J or L hooks, bolts and nuts 8 mm diameter with bitumen and G.I. limpet washers or with G.I. limpet washers filled with white lead, including a coat of approved steel primer and two coats of approved paint on overlapping of sheets complete (up to any pitch in horizontal/ vertical or curved surfaces),	18.36	m2		

Section VIII. Specifications

Construction of 30 Nos. of Collective Marketing Centers under MLAMP- Ref. No: MBMA/MLAMP/ISC&ED/109/2024/IV-20A/



	<p>excluding the cost of purlins, rafters and trusses and including cutting to size and shape wherever required.</p> <p>g</p> <p>0.45 mm thick with zinc coating not less than 275 gm/sqm</p>				
24	<p>Providing and fixing water closet squatting pan (Indian type</p> <p>W.C. pan) with 100 mm sand Cast Iron P or S trap, 10 litre low level white P.V.C. flushing cistern, including flush pipe, with manually controlled device (handle lever) conforming to IS:7231, with all fittings and fixtures complete, including cutting and making good the walls and floors wherever required:</p> <p>a White Vitreous china Orissa pattern W.C. pan of size 580x440 mm with integral type foot rests</p>	1.00	Each		
25	<p>Providing and fixing white vitreous china flat back or wall corner type lipped front urinal basin of 430x260x350 mm and 340x410x265 mm sizes respectively with automatic flushing cistern with standard flush pipe and C.P. brass spreaders with brass unions and G.I clamps complete, including painting of fittings and brackets, cutting and making good the walls and floors wherever required:</p> <p>a One urinal basin with 5 litre white P.V.C. automatic flushing cistern</p>	2.00	Each		
26	<p>Providing and fixing white vitreous china pedestal type water closet (European type W.C. pan) with seat and lid, 10 litre low level white P.V.C. flushing cistern, including flush pipe, with manually controlled device (handle lever), conforming to IS:7231, with all fittings and fixtures complete, including cutting and making good the walls and floors wherever required: a W.C. pan with ISI marked white solid plastic seat and lid</p>	1.00	Each		



Section VIII. Specifications

Construction of 30 Nos. of Collective Markiting Centers under MLAMP- Ref. No: MBMA/MLAMP/ISC&ED/109/2024/W-20A/

27	<p>Providing and fixing wash basin with C.I. brackets, 15 mm</p> <p>C.P. brass pillar taps, 32 mm C.P. brass waste of standard pattern, including painting of fittings and brackets, cutting and making good the walls wherever require:</p> <p>a White Vitreous China Wash basin size 630x450 mm with a pair of 15 mm C.P. brass pillar taps</p>	2.00	Each		
Total Cost of Civil Works					

Electricals Works for CMC

Sl No	Descriptions of Items	Quantities	Unit	Rate	Amount
1	<p>Supplying with fittings & fixing complete 250 VICSP&N Main Switch (b) 32Amp Capacity Change Over Switch</p>	2	Each		
2	<p>Wiring in looping system with copper PVC cable 250/440 Volt grade of size 1.5sqmm of approved quality using PVC casing capping including 5 amperes switch Indian best quality ceiling rose etc.capable to a highest point.</p> <p>(a) Long point wiring upto 10mtsCopper cable 1.5sqmm L= 50m</p>	5	Each		
3	<p>Drawing main and sub main line with DGSD approved VIR or PVC 250/440 Volt grade copperconductor in pVC capping complete with all accessories</p> <p>(a) With 2x2.5 sqmm Copper conductor (b) With 2x4 sqmm Copper conductor (c) With 2x6 sqmm Copper conductor (d) Width 2x10 sqmm Copper conductor</p>	50 50 10 35	Per Meter Per Meter Per Meter Per Meter		

Section VIII. Specifications

Construction of 30 Nos. of Collective Marketing Centers under MLAMP- Ref. No: MBMA/MLAMP/ISC&ED/109/2024/W-20A



4	Supplying fitting and fixing of DX3 Isolators for AC applications upto 125A B. Triple pole 415 V © 63 Amp	1	Each			
5	Supplying & fixing of load Kontaktet Circuit BreakersDX3 MCB's for AC applications till 63 A C. Double pole 415 V (b) 6-32 Amp	3	Each			
6	Supplying fitting and fixing earthing with GI pipe of 200cm lay 40 dia. Including all accessories & providing masonry enclosure with cover plate having locking arrangement etc with Charcoal salt complete as required (a) G.I Pipe electrode	1	Each			
7	Providing fixing connecting and testing of lightning conductor (Air termination) made of 32mm dia GI pipe 2 metres long with 150x180mm dia galvanized base plate complete with all necessary accessories.	1	Each			
8	Supplying fitting & fixing of wall/table fan with all necessary attachments and accessories as required (a) 400mm Wall fan	3	Each			
9	Supplying fitting and fixing of LED retrofit lamps surface or wall mounted with all necessary accessories. © Photon ultra LED tubelight (v) 20W	1	Each			
10	Supplying fitting fixing complete polish brass bracket, 16mm dia and 23cm long with cast backplate and brass lamp holder with LED bulb surface or wall mounted with all necessary accessories (a) Bulb (iv) 9 W	3	Each			
Total Electrical Works For CMC						



Section VIII. Specifications

Construction of 30 Nos. of Collective Marketing Centers under MLAMP- Ref. No: MBMA/MLAMP/ISC&ED/109/2024/W-20A/

Dayworks Summary

	Amount (INR)	% Foreign
1. Total for dayworks: Labour		
2. Total for dayworks: Materials		
3. Total for dayworks: Contractor's Equipment		
Total for dayworks (Provisional Sum) (carried forward to Bid Summary, p. _____)		

a. The employer should insert local currency unit



Section XI. Contract Forms

Section XI (A). Notice of Intent to Award	122
Section XI (B). Letter of Acceptance	124
Section XI (C). Contract Agreement.....	125
Section XI (D). Bank Guarantee Form for Advance Payment	127
Section XI (E). Performance Security Form.....	128



Section XI (A). Notice of Intent to Award

This is not a notification of award or letter of acceptance. The employer intends to contract to be formed with this notice.

[letterhead paper of the employer]

Insert project logo (if existing)

For the attention of the bidder's authorized representative

Name: *[insert authorized representative's name]*

Address: *[insert authorized representative's address]*

Telephone/Fax numbers: *[insert authorized representative's telephone/fax numbers]*

Email Address: *[insert authorized representative's email address]*

DATE OF TRANSMISSION: *[insert date]*

Procuring entity: *[insert the name of the procuring entity]*

Procurement title: *[insert]*

Ref no: *[insert]*

This notice of intent to award (NOITA) notifies you of our decision to award the above contract to *[insert the successful bidder]*.

Please note that this notice does not constitute any contract between the procuring entity and the bidder and neither establishes any legal rights or obligations for the procuring entity or bidder.



[IMPORTANT: provide the results of the evaluation and the prices of each bidder [if applicable] in this NOITA].

Name of bidder	Points scored	Bid price	Evaluated bid price (if applicable)
[insert name]	[insert points]	[insert bid price]	[insert evaluated price]
[insert name]	[insert points]	[insert bid price]	[insert evaluated price]
[insert name]	[insert points]	[insert bid price]	[insert evaluated price]
[insert name]	[insert points]	[insert bid price]	[insert evaluated price]
[insert name]	[insert points]	[insert bid price]	[insert evaluated price]

If your bid has not been successful, you may request a debriefing in relation to the results of the evaluation of your bid. If you decide to request a debriefing, your written request must be made within [insert number of stated in the bidding document and see the module M1 on debriefs in the IFAD Procurement Handbook for more information] business days of receipt of this NOITA.

If your request for a debriefing is received within the deadline above, we will provide the debriefing within [insert number stated in the bidding document and see the module M1 on debriefs in the IFAD Procurement Handbook for more information] business days of receipt of your request.

The debriefing may be in writing, by video conference call or in person. We shall promptly advise you in writing how the debriefing will take place and confirm the date and time.

The period within which you can protest the procurement proceedings lasts [insert number stated in the bidding document and see the module M2 on protests in the IFAD Procurement Handbook for more information] business days after the date of transmission of this NOITA.

Yours sincerely,

Authorised Official



Section XI (B). Letter of Acceptance

Notes on standard form of letter of acceptance

The letter of acceptance will be the basis for formation of the contract as described in clauses 35.1 of the Instructions to Bidders. This standard form of letter of acceptance is included for information at the bidding stage and shall be filled in and sent to the successful bidder only after evaluation of bids has been completed.

[letterhead paper of the employer]

_____ *[date]*

To: _____
[name of the contractor]

[address of the contractor]

This is to notify you that your bid dated _____ for the execution of the _____
[name of the contract and identification number, as given in the SCC]
for the Contract Price of _____ (_____) *[amount in numbers and words]* _____, as corrected and modified in accordance with the instruction to bidders, is hereby accepted by the employer.

You are hereby instructed to proceed with the execution of the said works in accordance with the contract documents.

Authorized Signature: _____

Name and Title of Signatory: _____

Name of Agency: _____

Attachment: Contract Agreement



Section XI (C). Contract Agreement

Notes on standard form of agreement

The agreement should incorporate any corrections or modifications to the bid resulting from price corrections and price adjustment during the evaluation process as provided for the in the Instructions to Bidders and any other agreement following award of the contract.

Contract Agreement

This Agreement, made the _____ day of _____ 202 _____
_____, between _____

[name and address of employer] (hereinafter called "the employer") and _____

_____ *[name and address of contractor]* (hereinafter called "the contractor") of the other part.

Whereas the employer is desirous that the contractor execute _____

[name and identification number of contract] (hereinafter called "the works") and the employer has accepted the bid by the contractor for the execution and completion of such works and the remedying of any defects therein.

Now with this agreement witnesseth as follow:

1. In this agreement, words and expressions shall have the same meanings as are respectively assigned to them in the conditions of contract hereinafter referred to, and they shall be deemed to form and be read and construed as part of this agreement.
2. The following documents shall be deemed to form and be read and construed as part of the agreement and shall have the order of precedence as listed below:
 - a. Agreement,
 - b. Letter of acceptance
 - c. Contractor's letter of bid
 - d. Special conditions of contract- SCC
 - e. General conditions of contract-GCC



Section XI. Contract Forms

Construction of 30 Nos. of Collective Marketing Centers under MLAMP- Ref. No: MBMA/MLAMP/ISC&ED/109/2024/W-20A/

- f. Specifications
- g. Drawings
- h. Bills of quantities (or activity schedules), and
- i. Any other documents listed in the SCC as forming part of the contract.

3. In consideration of the payments to be made by the employer to the contractor as specified in the letter of acceptance, the contractor hereby covenants with the employer to execute the works and to remedy defects therein in conformity in all respects with the provisions of the contract.
4. The employer hereby covenants to pay the contractor in consideration of the execution and completion of the works and the remedying of defects therein, the contract price or such other sum as may become payable under the provisions of the contract at the times and in the manner prescribed by the contract.
5. IN WITNESS whereof the parties hereto have caused this agreement to be executed in accordance with the laws of *[name of the borrowing country]*.on the day, month and year specified above.

<p>Signed by: _____</p> <p>for and on behalf of the Employer</p> <p style="text-align: center;">in the presence of: _____</p> <p>Witness, Name, Signature, Address, Date</p>	<p>Signed by: _____</p> <p>for and on behalf the Contractor</p> <p style="text-align: center;">in the presence of: _____</p> <p>Witness, Name, Signature, Address, Date</p>
--	---



Section XI (D). Bank Guarantee Form for Advance Payment

This sample of advance payment guarantee is for information only. Bidders should not complete the form at this time as only the successful bidder will be required to provide the advance payment guarantee.

To: *[name and address of employer]*
[name and procurement number of contract]

Gentlemen:

In accordance with the provisions of the conditions of contract, clause 24 "Advance" of the above-mentioned contract, *[name and address of contractor]* (hereinafter called "the contractor") shall deposit with *[name of employer]* a bank guarantee to guarantee his proper and faithful performance under the said clause of the contract in an amount of *[amount of guarantee]* *[amount in words]*.⁶

We, the *[bank or financial institution]*, as instructed by the contractor, agree unconditionally and irrevocably to guarantee as primary obligator and not as surety merely, the payment to *[name of employer]* on his first demand without whatsoever right of objection on our part and without his first claim to the contractor, in the amount not exceeding *[amount of guarantee]* *[amount in words]*.

We further agree that no change or addition to or other modification of the terms of the contract or of works to be performed thereunder or of any of the contract documents which may be made between *[name of employer]* and the contractor, shall in any way release us from any liability under this guarantee, and we hereby waive notice of any such change, addition, or modification.

This guarantee shall remain valid and in full effect from the date of the advance payment under the contract until *[name of employer]* receives full repayment of the same amount from the contractor.

This guarantee is subject to the Uniform Rules for Demand Guarantees, 2010 Revision, ICC Publication No. 758, except that the supporting statement requirement of Article 15(a) is hereby excluded and as may otherwise be stated above.

Yours truly,

Signature and seal: _____

Name of Bank: _____

Address: _____

⁶ An amount is to be inserted by the Bank or Financial Institution representing the amount of the Advance Payment, and denominated either in the currency(ies) of the Advance Payment as specified in the Contract, or in a freely convertible currency acceptable to the Employer.



Date: _____

Section XI (E). Performance Security Form

To: *[name of employer]*

WHEREAS *[name of contractor]* (hereinafter called "the contractor") has undertaken, in pursuance of contract No. *[reference number of the contract]* dated *[insert contract date]* to supply *[description of works]* (hereinafter called "the contract").

AND WHEREAS it has been stipulated by you in the said contract that the contractor shall furnish you with a bank guarantee by a reputable bank for the sum specified therein as security for compliance with the contractor's performance obligations in accordance with the contract.

AND WHEREAS we have agreed to give the contractor a guarantee:

THEREFORE WE hereby affirm that we are guarantors and responsible to you, on behalf of the contractor, up to a total of *[amount of the guarantee in words and figures]*, and we undertake to pay you, upon your first written demand declaring the contractor to be in default under the contract and without cavil or argument, any sum or sums within the limits of *[amount of guarantee]* as aforesaid, without your needing to prove or to show grounds or reasons for your demand or the sum specified therein.

This guarantee is valid until the _____ day of _____ 20 .

This guarantee is subject to the Uniform Rules for Demand Guarantees, 2010 Revision, ICC Publication No. 758, except that the supporting statement requirement of Article 15(a) is hereby excluded and as may otherwise be stated above.

Signature and seal of the guarantors

[name of bank or financial institution]

[address]



Section XI (F). Self-Certification Form

This self-certification form is to be completed by the contractor. The contractor shall submit the completed form together with the signed contract agreement to *[insert name of procuring entity]*. Instructions for completing this form are provided below.

Full legal name of contractor:	
Full legal name of contractor's legal representative and position:	
Full name and number of contract:	
Project with which contract was signed:	
Country:	
Date:	

I hereby certify that I am the authorized representative of *[name of the contractor]*, as well as that the information provided herein is true and accurate in all material respects and understand that any material misstatement, misrepresentation or failure to provide the information requested in this self-certification may result in sanctions and remedies, including the suspension or termination of the contract between the contractor and the procuring entity, as well as the permanent ineligibility to participate in IFAD-financed and/or IFAD-managed activities and operations, in accordance with the IFAD Procurement Guidelines, the IFAD Procurement Handbook and other applicable IFAD policies and procedures, including **IFAD's Policy on Preventing Fraud and Corruption in its Activities and Operations** (accessible at www.ifad.org/anticorruption_policy) and its **Policy on Preventing and Responding to Sexual Harassment, Sexual Exploitation and Abuse** (accessible at <https://www.ifad.org/en/document-detail/asset/40738506>).

Authorized Signature: _____ **Date:** _____

Printed Name of Signatory: _____



- The contractor certifies that itself, including its director(s), partner(s), proprietor(s), key personnel, agents, sub-consultants, sub-contractors, consortium and joint venture partners have **NOT** engaged in fraudulent, corrupt, collusive, coercive or obstructive practices, in connection with the present procurement process and this contract.
- The contractor declares that the following criminal convictions, administrative sanctions (including debarments under the Agreement for Mutual Enforcement of Debarment Decisions or the "Cross-Debarment Agreement")⁷ and/or temporary suspensions have been imposed on the contractor and/or any of its directors, partners, proprietors, key personnel, agents, sub-consultants, sub-contractors, consortium and joint venture partners:

Nature of the measure (i.e., criminal conviction, administrative sanction or temporary suspension)	Imposed by	Name of party convicted, sanctioned or suspended (and relationship to contractor)	Grounds for the measure (i.e., fraud in procurement or corruption in contract execution)	Date and time (duration) of measure

If no criminal convictions, administrative sanctions or temporary suspensions have been imposed, indicate "none".

- The contractor certifies that its director(s), proprietor(s), and personnel, and the personnel of its agents, sub-consultants, sub-contractors, consortium and joint venture partners are **NOT** subject to a criminal conviction, administrative sanctions or investigations for incidents of sexual harassment and sexual exploitation and abuse.
- The contractor certifies that itself, its proprietor(s), agents, sub-consultants, sub-contractors, consortium and joint venture partners have **NO** actual, potential or reasonably perceived conflicts of interest and specifically that they:

- Do not have any actual or potential, and do not reasonably appear to have, at least one controlling partner in common with one or more other parties in the bidding process or the execution of the contract ;
- Do not have any actual or potential, and do not reasonably appear to have the same legal representative as another bidder for purposes of this bid or execution of the contract;
- Do not have any actual or potential, and do not reasonably appear to have a relationship, directly or through common third parties, that puts them in a position to have access to undue or undisclosed information about or influence over the bid process and the execution of the contract, or influence the decisions of the procuring entity regarding the selection process for this procurement or during the execution of the contract;
- Do not participate and do not potentially or reasonably appear to participate in more than one bid in this process; and
- Do not have any actual or potential, and do not reasonably appear to have, a business or family relationship with, a member of the procuring entity's board of directors or its personnel , the Fund or its personnel, or any other individual that was, has been or might reasonably be directly or indirectly involved in any part of (i) the preparation of the bidding document, (ii) the selection process for this procurement, or (iii) execution of the contract, unless the actual, potential or reasonably conflict stemming from this relationship has been explicitly authorized by the Fund in writing.
- To be completed only if the previous boxes were not checked]**
The contractor declares the following actual, potential or reasonably perceived conflicts of interest, that may affect, or might reasonably be perceived by others to affect, impartiality in any matter relevant to the procurement process, including the selection process and the execution of the contract, with the understanding and acceptance that any action upon this disclosure shall be entirely under the Fund's discretion:

[provide detailed description of any actual, potential or reasonably perceived conflicts of interest including their nature and the personnel, proprietor(s), agents, sub-consultants, sub-contractors, consortium or joint venture partners affected.]

- The contractor certifies that **NO** gratuities, fees, commissions, gifts or anything else of value, other than those shown in the bid, have been paid or exchanged or are to be paid or exchanged with respect to the present procurement process and this contract.

OR

- [To be completed only if the previous box was not checked]**
The contractor declares that the following gratuities, fees, commissions, gifts or anything else of value have been exchanged, paid or are to be exchanged or paid with respect to the present procurement process and this contract:

[Name of Recipient/Address/Date/Reason/ Amount]
[Name of Recipient/Address/Date/Reason/ Amount]

- The contractor acknowledges and accepts to notify the procuring entity in the event of any material change in connection with this self-certification form throughout the duration of the contract.



⁷ The Cross-Debarment Agreement was entered into by the World Bank Group, the Inter-American Development Bank, the Section XI. Contract Forms

Instructions for completing the self-certification form

The World Bank listing of ineligible firms and individuals is a searchable database that returns a positive or negative search results page upon submission of a name to be searched, in order to document the eligibility.

The contractor should print out, date, and attach the results page(s) to the self-certification form, which should read, "no matching records found".

If (a) record(s) has/have been found – i.e. the results page(s) shows one or more individuals or entities, including the contractor itself are ineligible for contracts of the World Bank on the grounds of "cross-debarment", the contractor should provide a detailed account of these sanctions and their duration as applicable or notify the procuring entity and in case the contractor believes the finding is a "false positive".

The procuring entity will determine whether to proceed with the contract or allow the contractor to make a substitution. This determination will be made on a case by case basis and will require approval by IFAD regardless of the estimated value of the proposed contract.

All of these documents must be retained by the contractor as part of the overall record of the contract with the procuring entity for the duration of the contract and for a minimum period of three years following the completion of the contract.



African Development Bank, the Asian Development Bank and the European Bank for Reconstruction and Development, additional information may be located at: <http://crossdebarment.org/>.

Section XI. Contract Forms

Construction of 30 Nos. of Collective Marketing Centers under MLAMP- Ref. No: MBMA/MLAMP/ISC&ED/109/2024/W-20A/

Section XI (G). Revised IFAD Policy on Preventing Fraud and Corruption in its Activities and Operations

I. Introduction

1. The Fund recognizes that the prevention and mitigation of fraud and corruption in its activities and operations are core components of its development mandate and fiduciary duties. The Fund does not tolerate the diversion or waste of its resources through the practices defined in paragraph 6 below.
2. The objective of this policy is to establish the general principles, responsibilities and procedures to be applied by the Fund in preventing and addressing prohibited practices in its activities and operations.
3. This policy takes effect on the date of its issuance. It supersedes and replaces the IFAD Policy on Preventing Fraud and Corruption in its Activities and Operations (EB 2005/85/R.5/Rev.1) dated 24 November 2005.

II. Policy

A. General principles

4. The Fund has no tolerance towards prohibited practices in its activities and operations. All individuals and entities listed in paragraph 7 below must take appropriate action to prevent, mitigate and combat prohibited practices when participating in an IFAD-financed and/or IFAD-managed operation or activity.
5. The Fund endeavours to ensure that individuals and entities that help to prevent or report, in good faith, allegations of prohibited practices are protected against retaliation and to protect individuals and entities that are the subject of unfair or malicious allegations.

B. Prohibited practices

6. The following practices are considered to be prohibited practices when engaged in connection with an IFAD-financed and/or IFAD-managed operation or activity:
 - (a) A "corrupt practice" is the offering, giving, receiving or soliciting, directly or indirectly, of anything of value in order to improperly influence the actions of another party;
 - (b) A "fraudulent practice" is any act or omission, including a misrepresentation, that knowingly or recklessly misleads, or attempts to mislead, a party in order to obtain a financial or other benefit or to avoid an obligation;
 - (c) A "collusive practice" is an arrangement between two or more parties designed to achieve an improper purpose, including improperly influencing the actions of another party;

- (d) A “coercive practice” is impairing or harming, or threatening to impair or harm, directly or indirectly, any party or the property of the party in order to improperly influence the actions of that or another party;
- (e) An “obstructive practice” is: (i) deliberately destroying, falsifying, altering or concealing evidence that may be material to an investigation by the Fund or making false statements to investigators in order to materially impede an investigation by the Fund; (ii) threatening, harassing or intimidating any party in order to prevent that party from disclosing its knowledge of matters relevant to an investigation by the Fund or from pursuing such an investigation; and/or (iii) the commission of any act intended to materially impede the exercise of the Fund’s contractual rights of audit, inspection and access to information.

C. Scope

7. This policy applies to all IFAD-financed and/or IFAD-managed operations and activities and to the following individuals and entities:
 - (a) IFAD staff and other persons working for IFAD as non-staff personnel (“IFAD staff and non-staff personnel”);
 - (b) staff and non-staff personnel”);
 - (c) Individuals and entities holding a commercial contract with the Fund and any of their agents or personnel (“vendors”);
 - (d) Public entities receiving IFAD financing or financing managed by the Fund and any of their agents or personnel (“government recipients”) and private entities receiving IFAD financing or financing managed by the Fund and any of their agents or personnel (“non-government recipients”) (all collectively referred to as “recipients”); and
 - (e) Individuals and entities, other than those referred to above, that receive, apply to receive, are responsible for the deposit or transfer of, or take or influence decisions regarding the use of proceeds from IFAD financing or financing managed by the Fund, including, but not limited to, implementing partners, service providers, contractors, suppliers, subcontractors, sub-suppliers, bidders, consultants and any of their agents or personnel. (All such individuals and entities are collectively referred to as “third parties”.)

D. Responsibilities

(i) Responsibilities of the Fund

8. The Fund endeavours to prevent, mitigate and combat prohibited practices in its operations and activities. This may include adopting and maintaining:
 - (a) Communication channels and a legal framework designed to ensure that this policy is communicated to IFAD staff and non-staff personnel, vendors, recipients and third parties and that it is reflected in procurement documents and contracts relating to IFAD-financed and/or IFAD-managed activities and operations;



- (b) Fiduciary controls and supervisory processes designed to support adherence to this policy by IFAD staff and non-staff personnel, vendors, recipients and third parties;
- (c) Measures relating to the receipt of confidential complaints, whistle-blower protection, investigations, sanctions and disciplinary measures which are designed to ensure that prohibited practices can be properly reported and addressed; and
- (d) Measures designed to ensure that the Fund can report individuals and entities that have been found to have engaged in prohibited practices to other multilateral organizations which may be exposed to similar actions by the same individuals and entities and to local authorities in cases where local laws may have been violated.

(ii) Responsibilities of IFAD staff and non-staff personnel, vendors and third parties

9. When participating in an IFAD-financed and/or IFAD-managed operation or activity, IFAD staff and non-staff personnel, vendors and third parties will:
- (a) Refrain from engaging in prohibited practices;
 - (b) Participate in due diligence checks and disclose, as required, information relating to themselves or any of their key personnel concerning relevant criminal convictions, administrative sanctions and/or temporary suspensions; information concerning agents engaged in connection with a procurement process or contract, including the commissions or fees paid or to be paid; and information concerning any actual or potential conflicts of interest in connection with a procurement process or the execution of a contract;
 - (c) Promptly report to the Fund any allegations or other indications of prohibited practices that come to their attention by virtue of their involvement in an IFAD-financed and/or IFAD-managed operation or activity;
 - (d) Fully cooperate with any investigation conducted by the Fund, including by making personnel available for interviews and providing full access to any and all accounts, premises, documents and records (including electronic records) relating to the relevant IFAD-financed and/or IFAD-managed operation or activity, and by having such accounts, premises, documents and records audited and/or inspected by auditors and/or investigators appointed by the Fund; and
 - (e) Maintain strict confidentiality regarding any and all information received as a consequence of their participation in an IFAD investigation or sanctioning process.
10. When participating in an IFAD-financed and/or IFAD-managed operation or activity, vendors and third parties will maintain all accounts, documents and records relating to that operation or activity for an adequate period of time, as specified in the relevant procurement documents or contract.

(iii) Responsibilities of recipients

11. When participating in an IFAD-financed and/or IFAD-managed operation or activity, recipients will take appropriate action to prevent, mitigate and combat prohibited practices. In particular, they will:



- (a) Adopt appropriate fiduciary and administrative practices and institutional arrangements in order to ensure that the proceeds of any IFAD financing or financing managed by the Fund are used only for the purposes for which they were provided;
- (b) During selection processes and/or prior to entering into a contractual relationship with a third party, conduct appropriate due diligence checks of the selected bidder or potential contractor, including by verifying whether the selected bidder or potential contractor is publicly debarred by any of the IFIs that are signatories to the Agreement for Mutual Enforcement of Debarment Decisions⁸ and, if so, whether the debarment meets the requirements for mutual recognition under the Agreement for Mutual Enforcement of Debarment Decisions;
- (c) Take appropriate action to inform third parties and beneficiaries (defined as “persons whom the Fund intends to serve through its grants and loans”) of the present policy as well as the Fund’s confidential and secure e-mail address for the receipt of complaints concerning prohibited practices;
- (d) Include provisions in procurement documents and contracts with third parties which:
 - (i) Require third parties to disclose, in the course of a procurement process and any time thereafter, information relating to themselves or any of their key personnel concerning relevant criminal convictions, administrative sanctions and/or temporary suspensions; information concerning agents engaged in connection with a procurement process or the execution of a contract, including the commissions or fees paid or to be paid; and information concerning any actual or potential conflicts of interest in connection with a procurement process or the execution of a contract;
 - (ii) Require third parties to promptly report to the Fund any allegations or other indications of prohibited practices that come to their attention by virtue of their involvement in an IFAD-financed and/or IFAD-managed operation or activity;
 - (iii) Inform third parties of the Fund’s jurisdiction to investigate allegations and other indications of prohibited practices and to impose sanctions on third parties for such practices in connection with an IFAD-financed and/or IFAD-managed operation or activity;
 - (iv) Require third parties to fully cooperate with any investigation conducted by the Fund, including by making personnel available for interviews and by providing full access to any and all accounts, premises, documents and records (including electronic records) relating to the relevant IFAD-financed and/or IFAD-managed operation or activity and to have such accounts, premises, records and documents audited and/or inspected
 - (v) by auditors and/or investigators appointed by the Fund;

⁸ The Agreement for Mutual Enforcement of Debarment Decisions, dated 9 April 2010, was signed by five of the leading IFIs, namely, the African Development Bank Group, the Asian Development Bank, the European Bank for Reconstruction and Development, the Inter-American Development Bank and the World Bank Group.

- (vi) Require third parties to maintain all accounts, documents and records relating to an IFAD-financed and/or IFAD-managed operation or activity for an adequate period of time as agreed with the Fund;
 - (vii) Inform third parties of the Fund's policy of unilaterally recognizing debarments imposed by other IFIs if such debarments meet the requirements for mutual recognition under the Agreement for Mutual Enforcement of Debarment Decisions; and
 - (viii) Provide for early contract termination or suspension by the recipient if such termination or suspension is required as a consequence of a temporary suspension or sanction imposed or recognized by the Fund;
- (e) Promptly inform the Fund of any allegations or other indications of Prohibited Practices that come to their attention;
 - (f) Fully cooperate with any investigation conducted by the Fund, including by making personnel available for interviews and by providing full access to any and all accounts, premises, documents and records (including electronic records) relating to the relevant IFAD-financed and/or IFAD-managed operation or activity and to have such accounts, premises, documents and records audited and/or inspected by auditors and/or investigators appointed by the Fund;
 - (g) Maintain all accounts, documents and records relating to an IFAD-financed and/or IFAD-managed operation or activity for an adequate period of time, as specified in the relevant financing agreement; and
 - (h) Maintain strict confidentiality regarding any and all information received as a consequence of their participation in an IFAD investigation or sanctioning process.
12. Where the Fund finds that prohibited practices have occurred, recipients will: (a) Take appropriate corrective measures in coordination with the Fund; and (b) Give full effect to any temporary suspension or sanction imposed or recognized by the Fund, including by not selecting a bidder, not entering into a contract or suspending or terminating a contractual relationship.
13. Prior to the implementation of an IFAD-financed and/or IFAD-managed operation or activity, government recipients will inform the Fund of the arrangements that they have made for receiving and taking action in response to allegations of fraud and corruption relating to the IFAD-financed and/or IFAD-managed operation or activity, including by designating an independent and competent local authority to be responsible for receiving, reviewing and investigating such allegations.
14. When participating in an IFAD-financed and/or IFAD-managed operation or activity, government recipients will, in consultation with the Fund, take timely and appropriate action to launch a local investigation into allegations and/or other indications of fraud and corruption relating to the IFAD-financed and/or IFAD-managed operation or activity; inform the Fund of the actions taken in any such investigation at such intervals as may be agreed upon by the recipient and the Fund on a case-by-case basis; and, upon the completion of such investigation, promptly share the findings and results thereof, including the supporting evidence, with the Fund. Government recipients will work with the Fund to coordinate any actions other than investigations

that they may wish to undertake in response to an alleged or otherwise indicated prohibited practice.

15. Government recipients are encouraged to have in place, in accordance with their laws and regulations, effective whistle-blower protection measures and confidential reporting channels in order to appropriately receive and address allegations of fraud and corruption relating to IFAD-financed and/or IFAD-managed operations and activities.

E. Process

(i) Reporting

16. A designated confidential and secure e-mail address for the receipt of allegations of prohibited practices is available on the Fund's website.
17. In the event of uncertainty as to whether or not an act or omission constitutes a prohibited practice, the designated confidential and secure e-mail address may be used to seek guidance.
18. The Fund treats all reported allegations with strict confidentiality. This means that the Fund does not normally reveal the identity of a reporting party to anybody outside of the investigative, sanctioning or disciplinary process without the consent of the reporting party.
19. The Fund endeavours to provide protection from retaliation to any individuals or entities that have helped prevent or have reported to the Fund, in good faith, allegations or other indications of prohibited practices. IFAD staff and non-staff personnel are protected from retaliation under the Fund's Whistle-blower Protection Procedures.

(ii) Investigations

20. Where the Fund has reason to believe that prohibited practices may have occurred, the Fund may decide to review and investigate the matter, irrespective of any investigative actions launched or planned by the recipient.
21. The purpose of an investigation conducted by the Fund is to determine whether an individual or entity has engaged in one or more prohibited practices in connection with an IFAD-financed and/or IFAD-managed operation or activity.
22. Reviews and investigations conducted by the Fund are, inter alia:
 - (a) Strictly confidential, meaning that the Fund does not disclose to anyone outside of the investigative, sanctioning or disciplinary process any evidence or information relating to the review or investigation, including the outcome of a review or investigation, unless such disclosure is allowed under the Fund's legal framework;
 - (b) Independent, meaning that no authority is allowed to interfere with an ongoing review or investigation or to otherwise intervene in, influence or stop such a review or investigation; and
 - (c) Administrative, as opposed to criminal, in nature, meaning that reviews and investigations conducted by the Fund are governed by the Fund's rules and procedures, not by local laws.

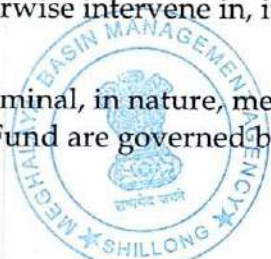

23. The office within the Fund that is mandated to conduct reviews and investigations into alleged or otherwise indicated prohibited practices is the Office of Audit and Oversight (AUO). Without prejudice to paragraphs 9(d) and 11(f), AUO may agree not to disclose to anybody outside of AUO any evidence or information that it has obtained on the condition that such evidence or information may be used solely for the purpose of generating new evidence or information, unless the provider of the evidence or information consents.

F. Sanctions and related measures

(i) Temporary suspensions

24. During the course of an IFAD review or investigation, or pending the conclusion of a sanctioning process, the Fund may decide, at any time, to temporarily suspend payments to IFAD non-staff personnel, non-government recipients, vendors or third parties or to temporarily suspend their eligibility to participate in IFAD- financed and/or IFAD-managed operations and activities for an initial period of six (6) months, subject to a possible extension of that suspension for an additional six (6) months.
25. IFAD staff may be temporarily suspended from their duties in accordance with the applicable human resources framework.

(ii) Sanctions

26. If the Fund determines that IFAD non-staff personnel, non-government recipients, vendors or third parties have engaged in prohibited practices, the Fund may impose administrative sanctions on such individuals or entities.
27. Sanctions are imposed on the basis of: (i) the findings and evidence presented by AUO, including mitigating and exculpatory evidence; and (ii) any evidence or arguments submitted by the subject of the investigation in response to the findings presented by AUO.
28. The Fund may apply any of the following sanctions or a combination thereof:
- (a) Debarment, which is defined as declaring an individual or entity ineligible, either indefinitely or for a stated period of time, to: (i) be awarded any IFAD- financed contract; (ii) benefit, financially or otherwise, from any IFAD- financed contract, including by being engaged as a subcontractor; and (iii) otherwise participate in the preparation or implementation of any IFAD- financed and/or IFAD-managed operation or activity;
 - (b) Debarment with conditional release, which is defined as a debarment that is terminated upon compliance with conditions set forth in the sanction decision;
 - (c) Conditional non-debarment, which is defined as requiring an individual or entity to comply with certain remedial, preventive or other measures as a condition for non-debarment on the understanding that a failure to comply with such measures within a prescribed period of time will result in an automatic debarment under the terms provided for in the sanction decision;
 - (d) Restitution, which is defined as a payment to another party or the Fund (with respect to the Fund's resources) of an amount equivalent to the amount of the

diverted funds or the economic benefit obtained as a result of having engaged in a prohibited practice; and

- (e) Letter of reprimand, which is defined as a formal letter of censure for the actions of an individual or entity which informs that individual or entity that any future violation will lead to more severe sanctions.

29. The Fund may extend the application of a sanction to any affiliate of a sanctioned party even if the affiliate has not been directly involved in the prohibited practice. An affiliate is defined as any individual or entity that is: (i) directly or indirectly controlled by the sanctioned party; (ii) under common ownership or control with the sanctioned party; or (iii) acting as an officer, employee or agent of the sanctioned party, including owners of the sanctioned party and/or those who exercise control over the sanctioned party.
30. For the purposes of IFAD-financed and/or IFAD-managed operations and activities, the Fund may consider as debarred individuals and entities that have been debarred by another IFI where: (i) that IFI is a signatory to the Agreement for Mutual Enforcement of Debarment Decisions; and (ii) such debarment meets the requirements for mutual recognition under the Agreement for Mutual Enforcement of Debarment Decisions.⁹

(iii) Disciplinary measures

31. If the Fund finds that IFAD staff have engaged in prohibited practices, the Fund may apply disciplinary measures and may require restitution or other compensation in accordance with the applicable human resources framework.

G. Referrals and information-sharing

32. The Fund may, at any time, refer information or evidence relating to an ongoing or completed investigative, sanctioning or disciplinary process to the local authorities of a Member State. In determining whether such a referral is appropriate, the Fund takes into consideration the interests of the Fund, the affected Member States, the individuals or entities under investigation and any other persons, such as witnesses, who are involved in the case.
33. If the Fund obtains information or evidence indicating potential wrongdoing in connection with the operations and/or activities of another multilateral organization, the Fund may make such information or evidence available to the other organization for the purposes of its own investigative, sanctioning or disciplinary processes.
34. In order to facilitate and regulate the confidential exchange of information and evidence with local authorities and multilateral organizations, the Fund seeks to conclude agreements which establish the rules for such an exchange.

H. Operational responses to Prohibited Practices

(i) Rejection of an award of contract

⁹ The Fund may, in the future, decide to also recognize debarments imposed by entities that are not signatories to the Agreement for Mutual Enforcement of Debarment Decisions.



35. The Fund may refuse to give its no-objection to the award of a contract to a third party if it determines that the third party, or any of its personnel, agents, subconsultants, subcontractors, service providers, suppliers and/or their employees, engaged in a prohibited practice while competing for the contract in question.

(ii) Declaration of misprocurement and/or ineligibility of expenditures

36. The Fund may, at any time, declare a misprocurement and/or the ineligibility of any expenditures associated with a procurement process or contract if it determines that a third party or a representative of the recipient has engaged in a prohibited practice in connection with the procurement process or contract at issue and that the recipient has not taken timely and appropriate action, satisfactory to the Fund, to address such practices when they occur.

(iii) Suspension or cancellation of loan or grant

37. If the Fund determines that a recipient has not taken timely and appropriate action, satisfactory to the Fund, to address prohibited practices when they occur, the Fund may suspend or cancel, in whole or in part, the loan or grant affected by such practices.

